

PAGE NUMBER	DESCRIPTION
2-7	ELEVATION PANEL DETAILS
8, 9	BASE DETAIL
10-12	HORIZONTAL JOINT DETAIL
13, 14	PARAPET DETAIL
15, 16	INSIDE CORNER DETAIL
17, 18	OUTSIDE CORNER DETAIL
19, 20	SOFFIT DETAIL
21, 22	WINDOW HEAD DETAIL
23, 24	WINDOW JAMB DETAIL
25, 26	WINDOW SILL DETAIL
27-30	PANEL JOINT DETAIL
31	ISOMETRIC WALL ASSEMBLY
32	TRIM PROFILE DETAILS



**WAARD
METALS**

ELEVATION SERIES

E-6

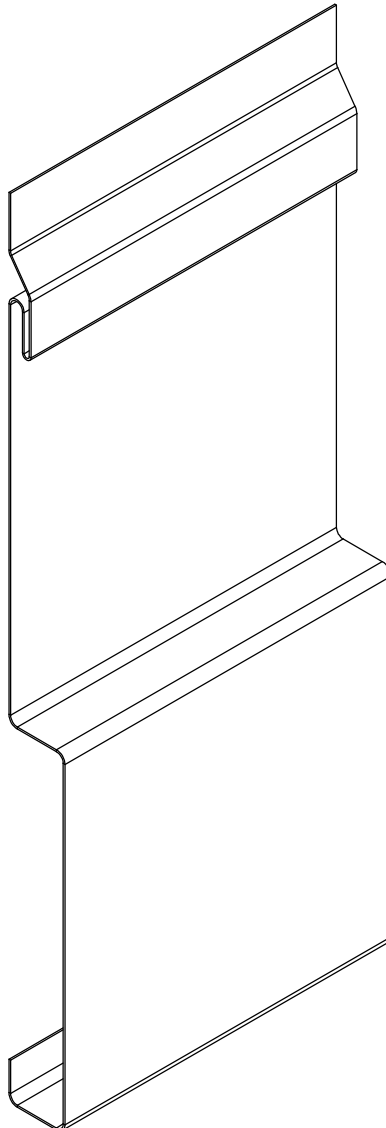
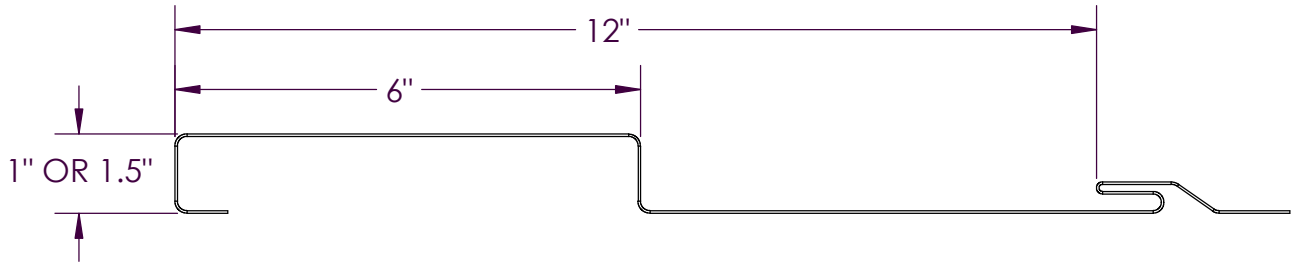



**WAARD
METALS**

ELEVATION SERIES

E-7

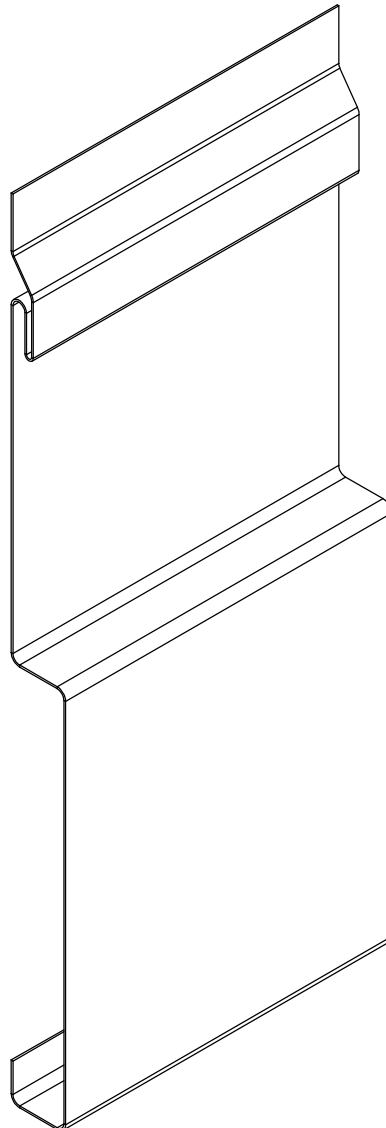
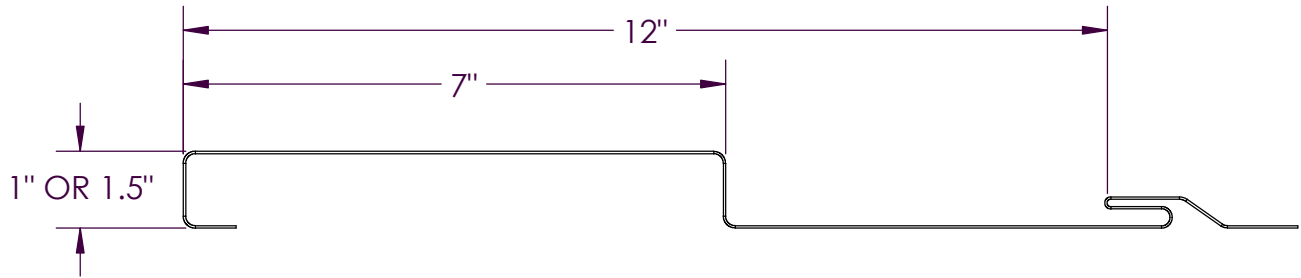



**WAARD
METALS**

ELEVATION SERIES

E-8

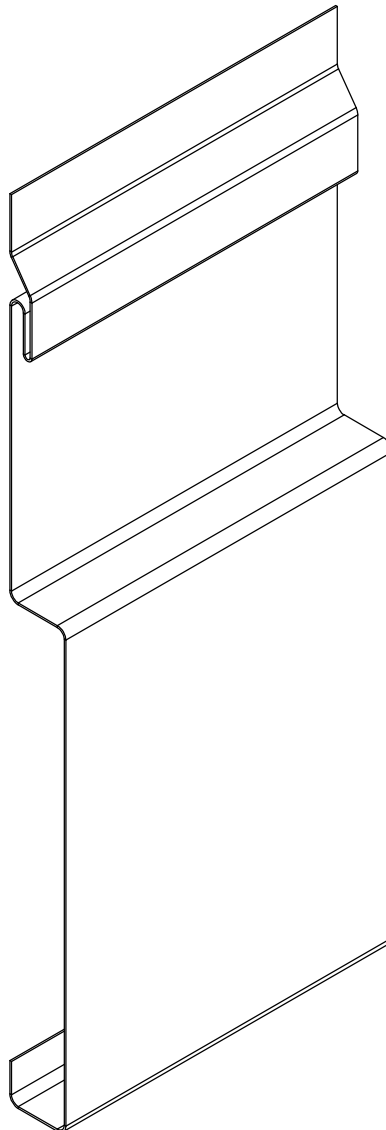
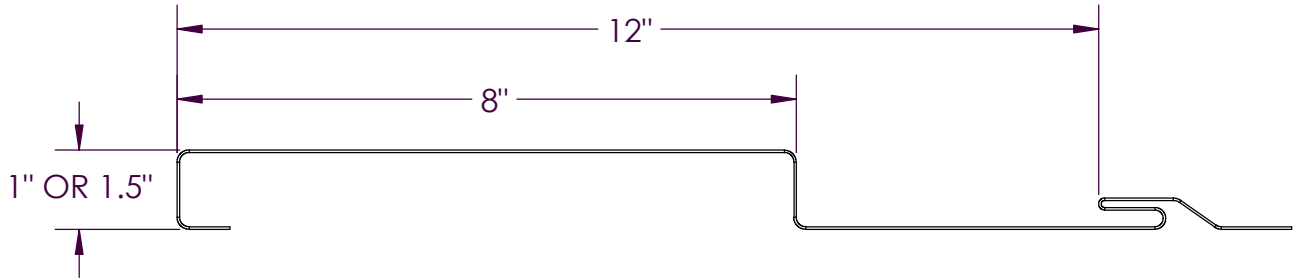



**WAARD
METALS**

ELEVATION SERIES

E-9

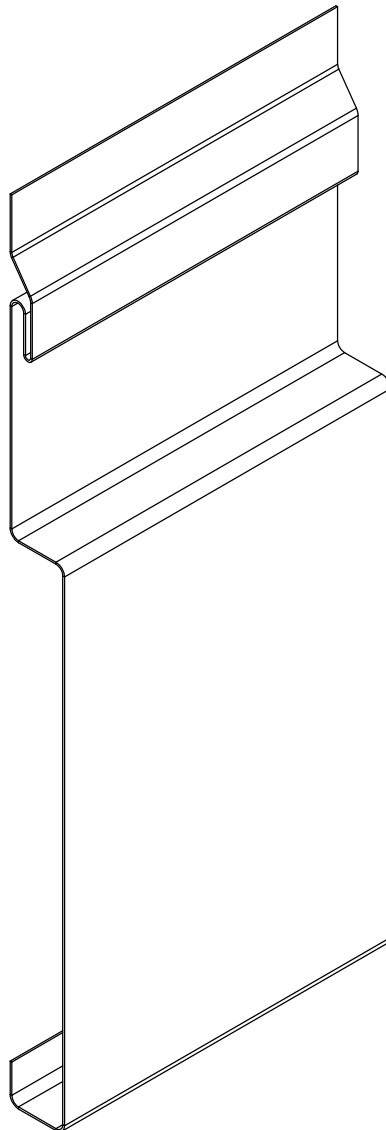
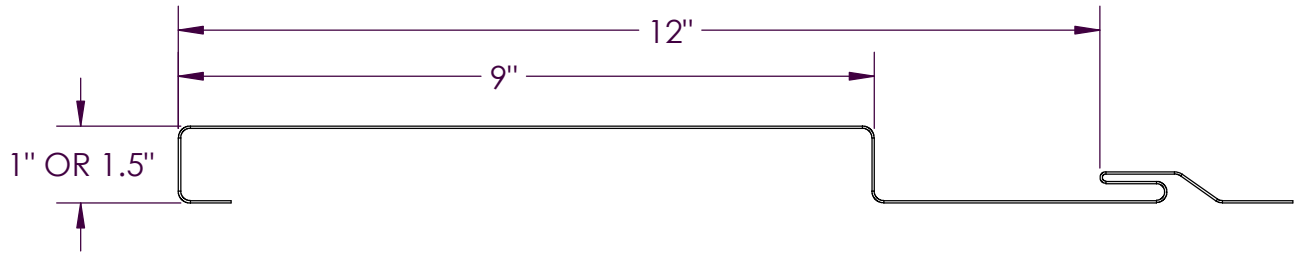



**WAARD
METALS**

ELEVATION SERIES

E-10

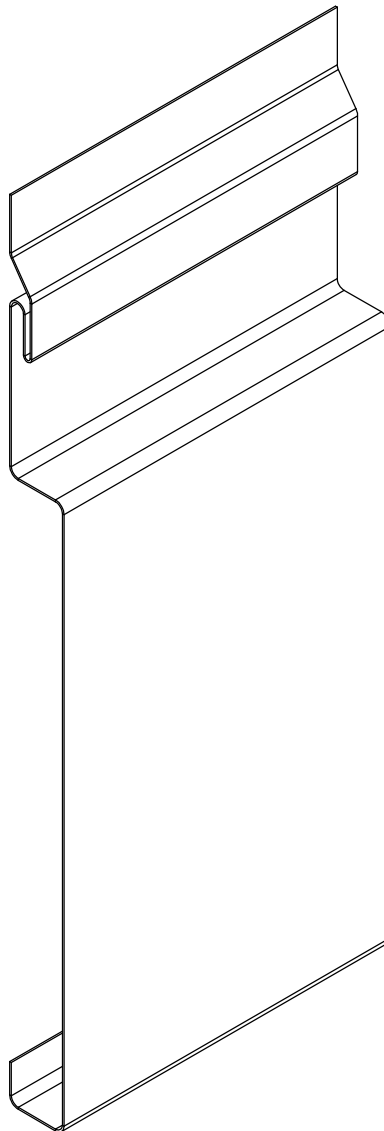
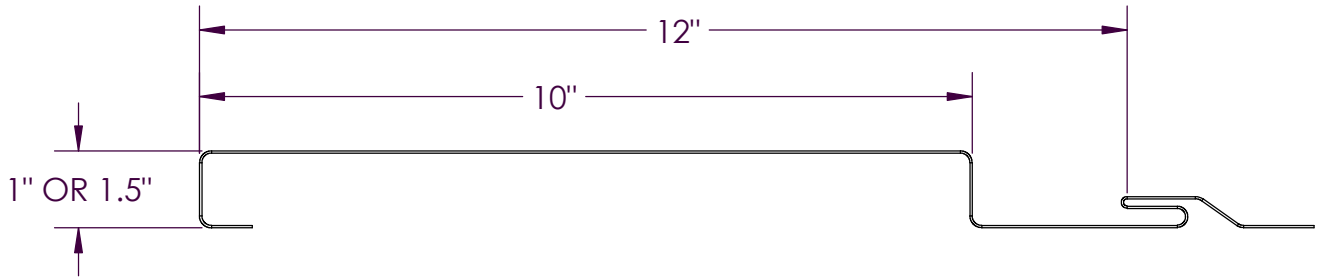



**WAARD
METALS**

ELEVATION SERIES

E-11

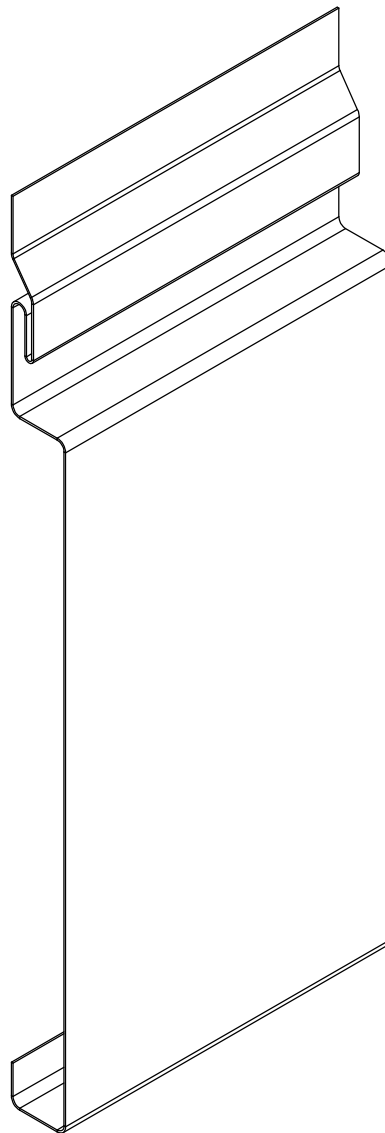
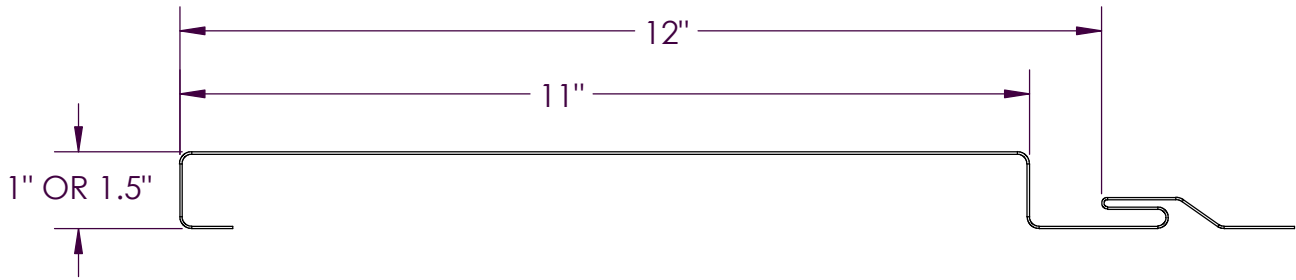



**WAARD
METALS**

ELEVATION SERIES

BASE DETAIL
NO INSULATION

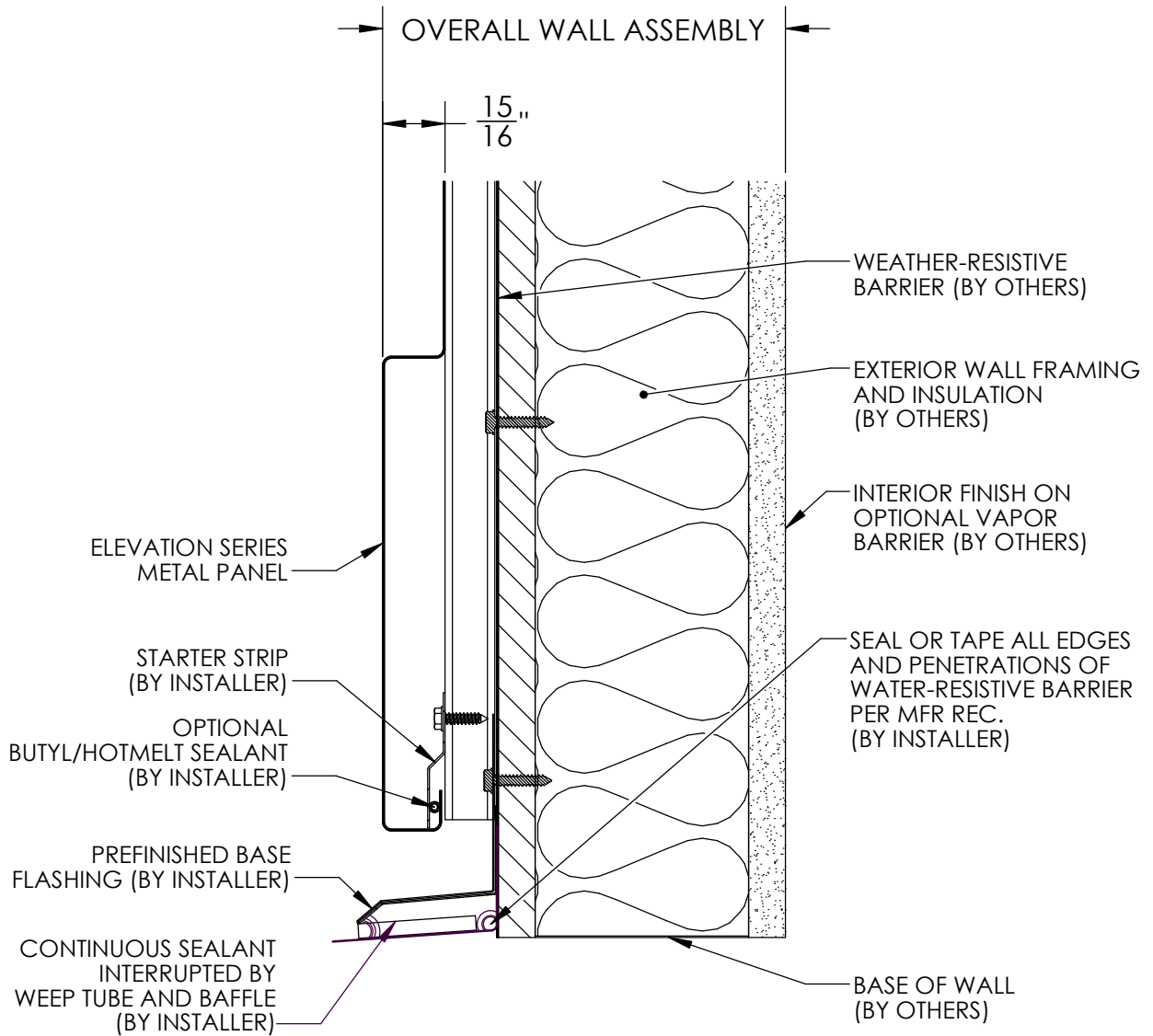



**WAARD
METALS**

ELEVATION SERIES

WALL BASE DETAIL
INSULATION

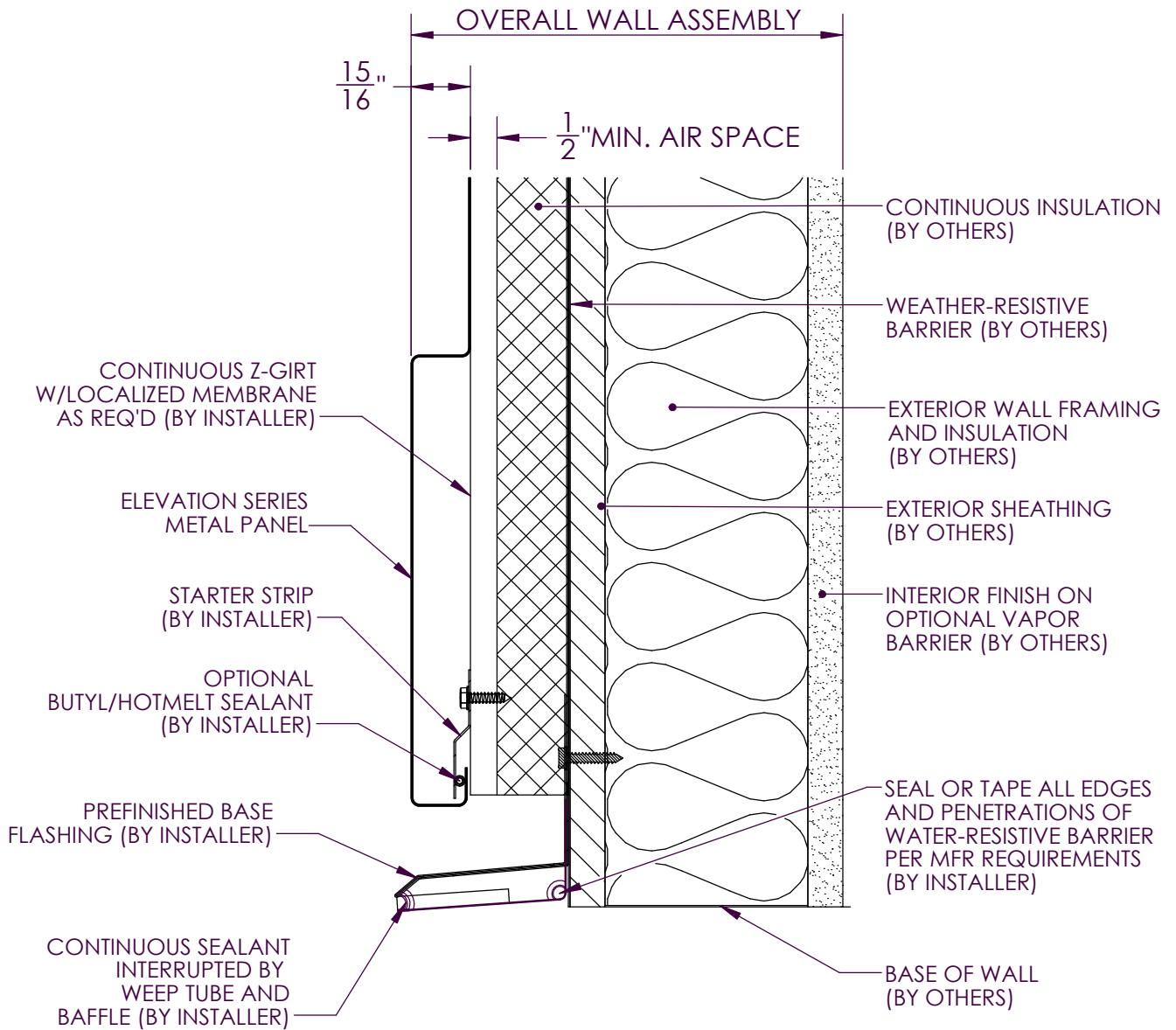



**WAARD
METALS**

ELEVATION SERIES

HORIZONTAL JOINT DETAIL
NO INSULATION

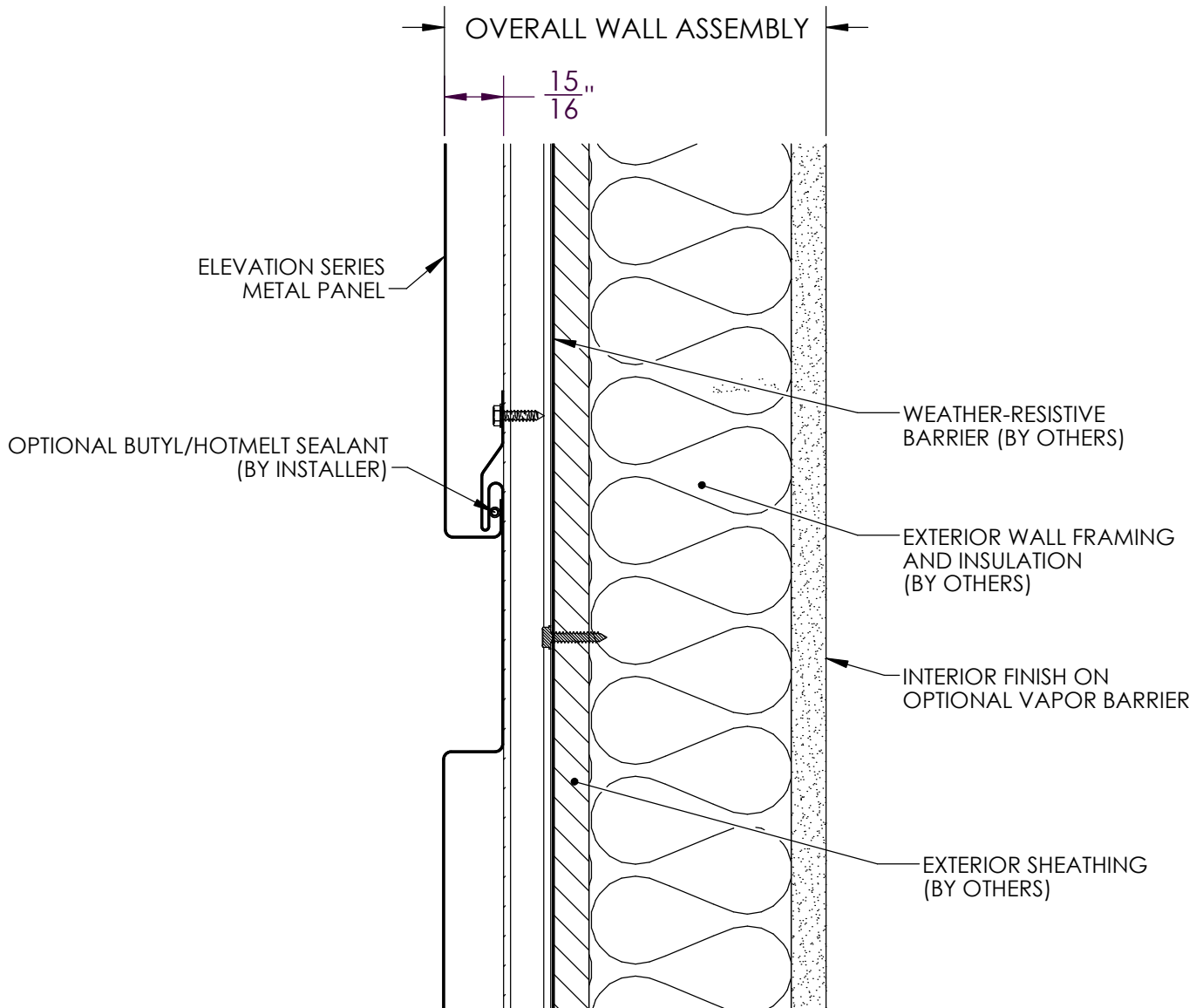



**WAARD
METALS**

ELEVATION SERIES

HORIZONTAL JOINT DETAIL
INSULATION

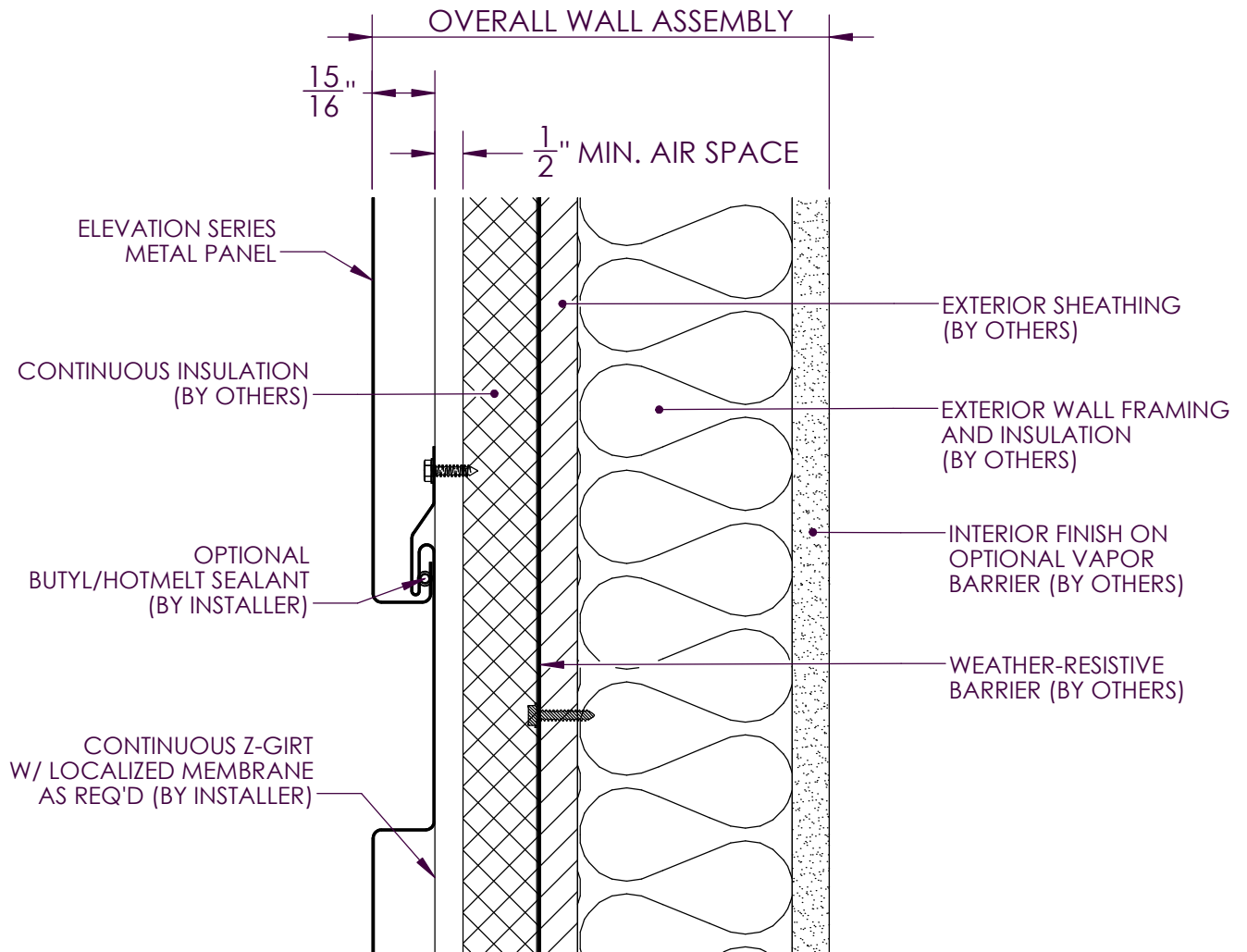



**WAARD
METALS**

ELEVATION SERIES

HORIZONTAL JOINT DETAIL
DIRECT FASTEN OPTION

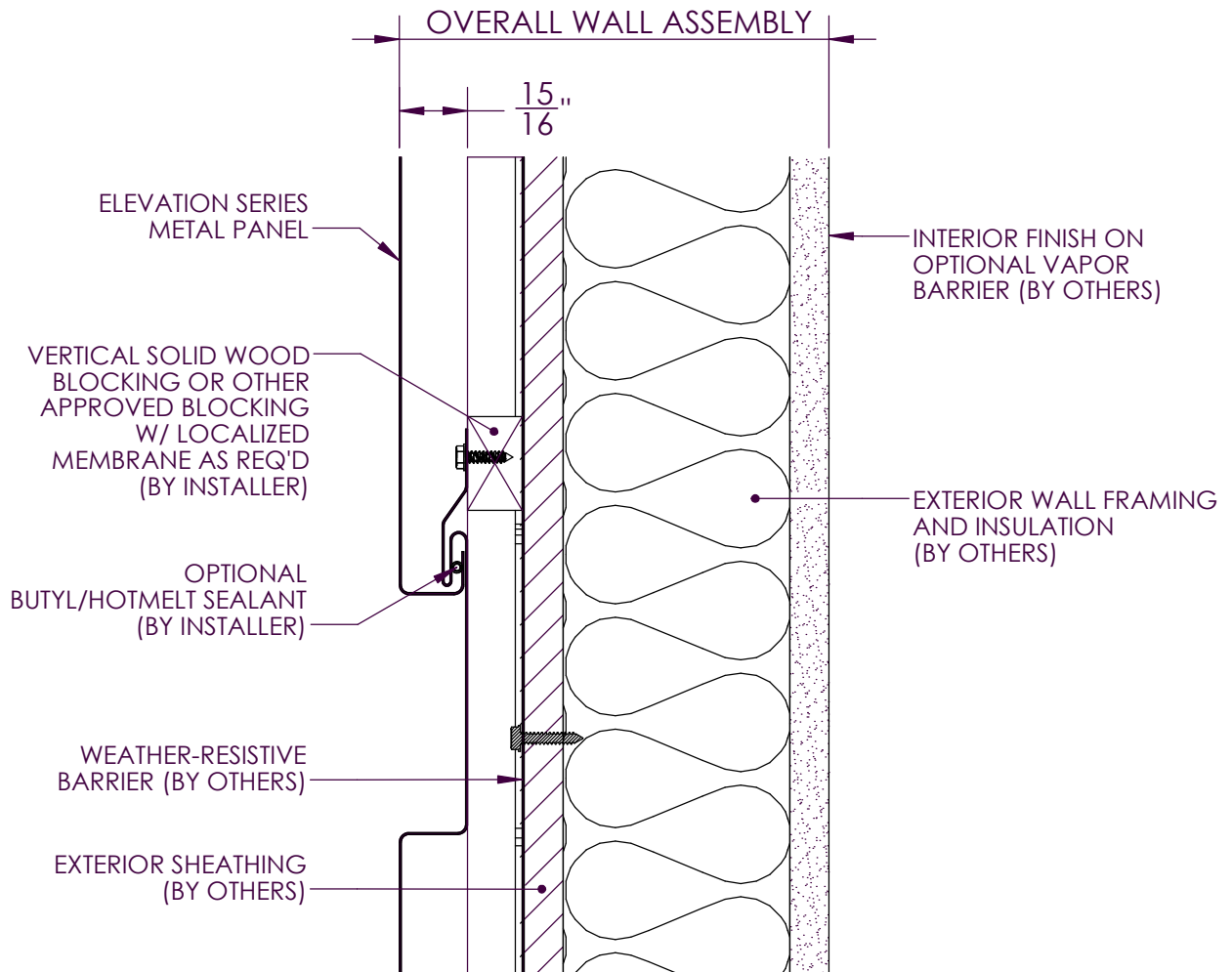



**WAARD
METALS**

ELEVATION SERIES

PARAPET ROOF DETAIL
NO INSULATION

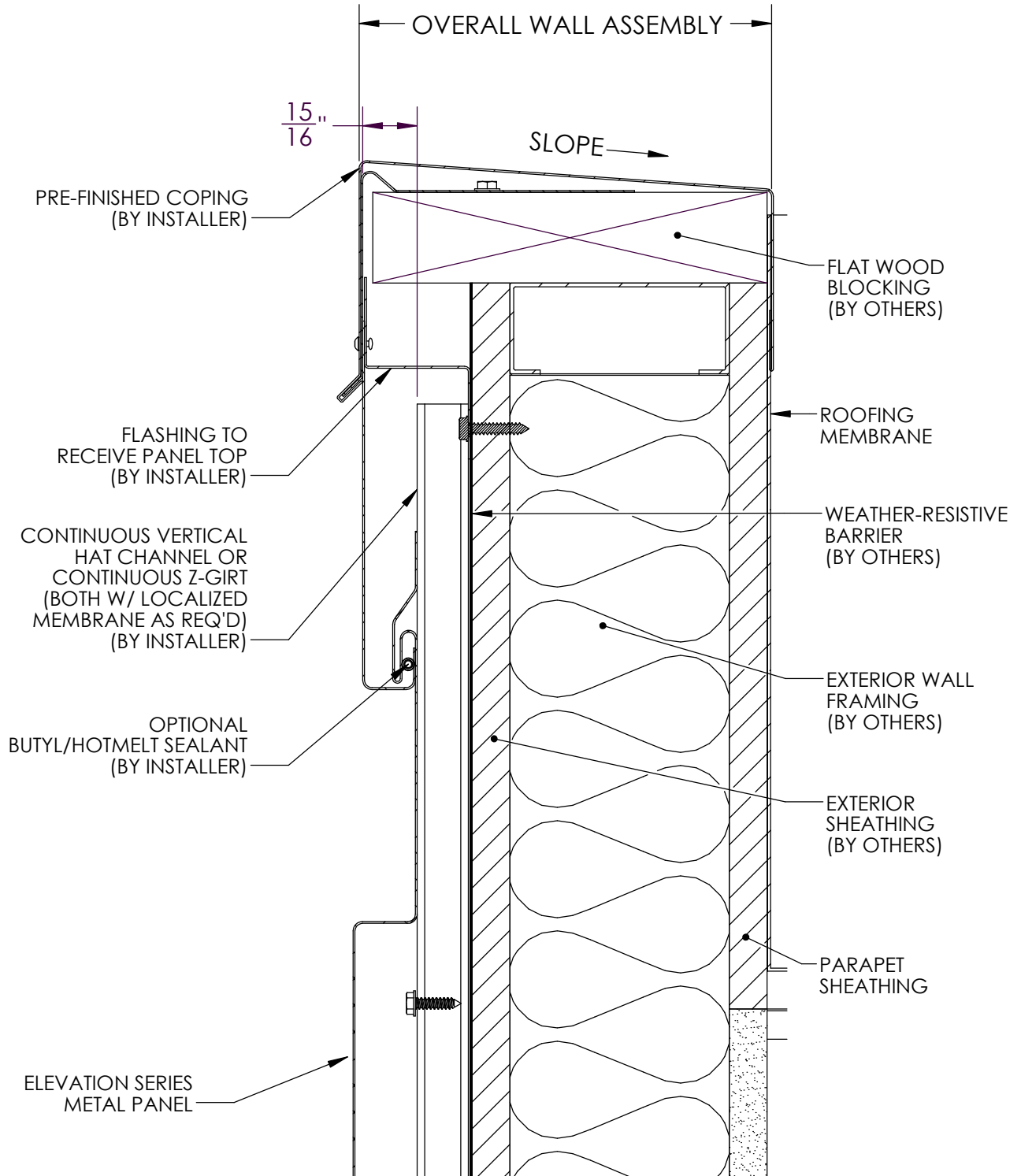



**WAARD
METALS**

ELEVATION SERIES

PARAPET ROOF DETAIL
INSULATION

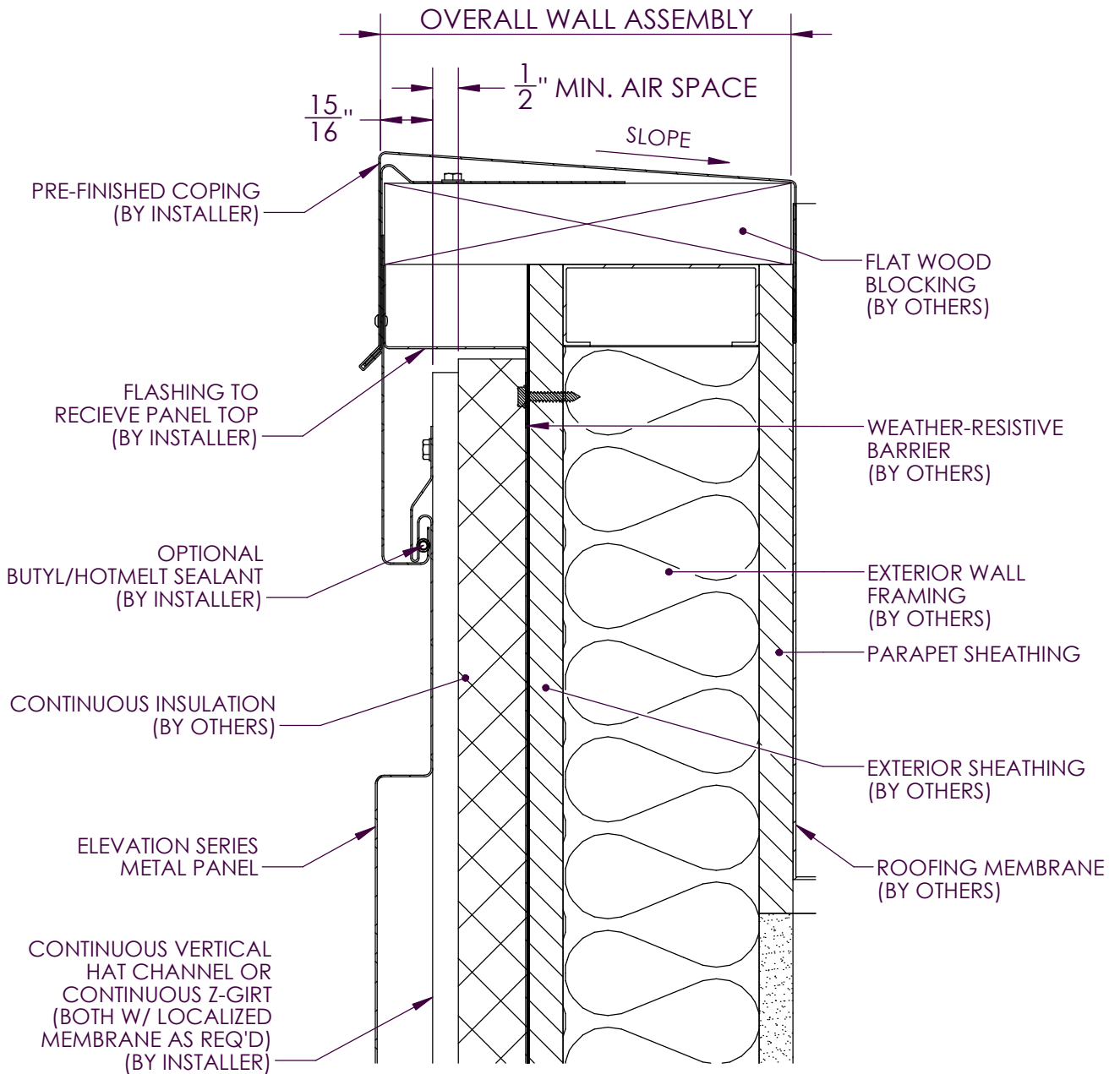



**WAARD
METALS**

ELEVATION SERIES

INSIDE CORNER DETAIL
NO INSULATION

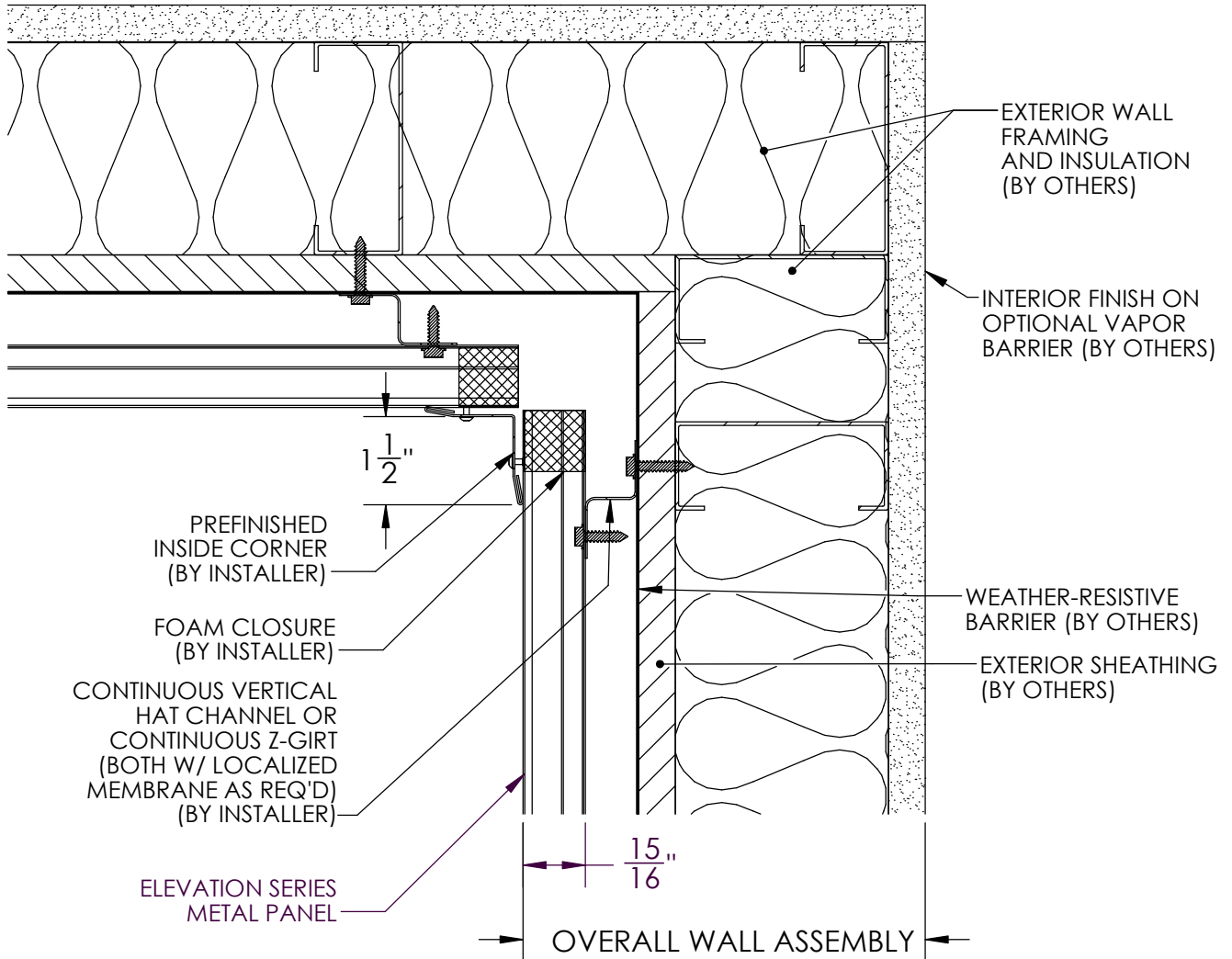



**WAARD
METALS**

ELEVATION SERIES

INSIDE CORNER DETAIL
INSULATION

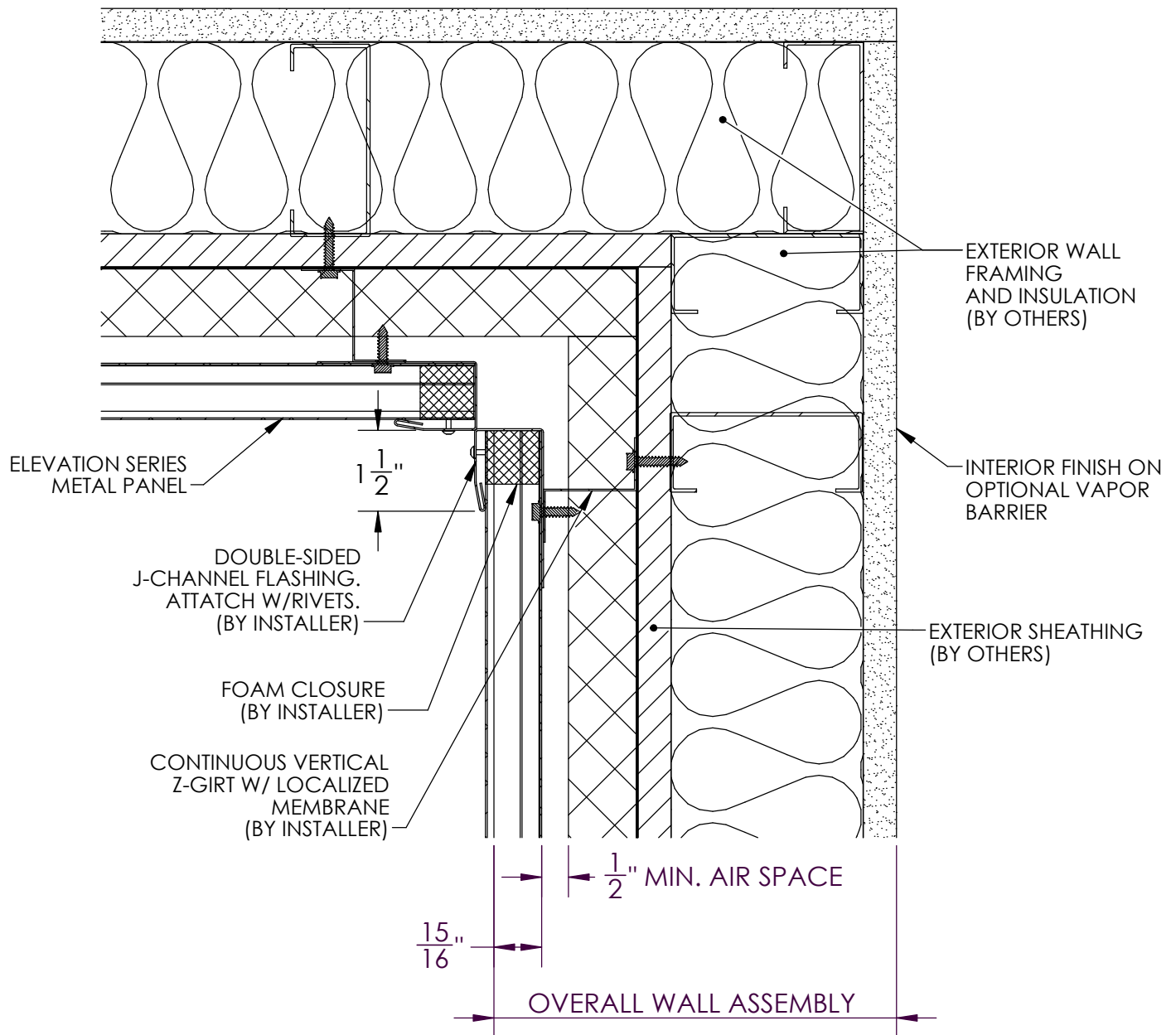



**WAARD
METALS**

ELEVATION SERIES

OUTSIDE CORNER
NO INSULATION

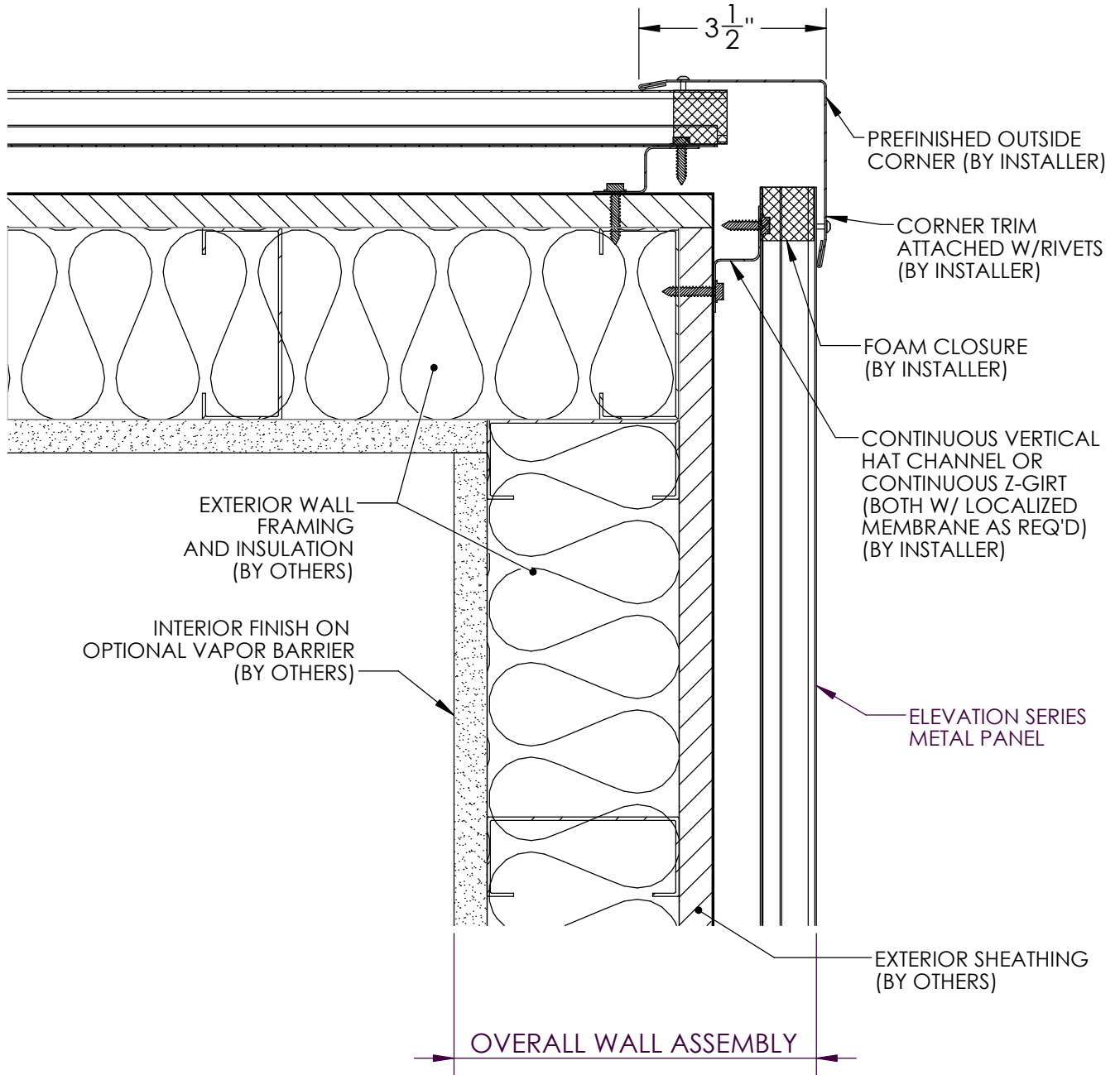



**WAARD
METALS**

ELEVATION SERIES

OUTSIDE CORNER DETAIL
INSULATION

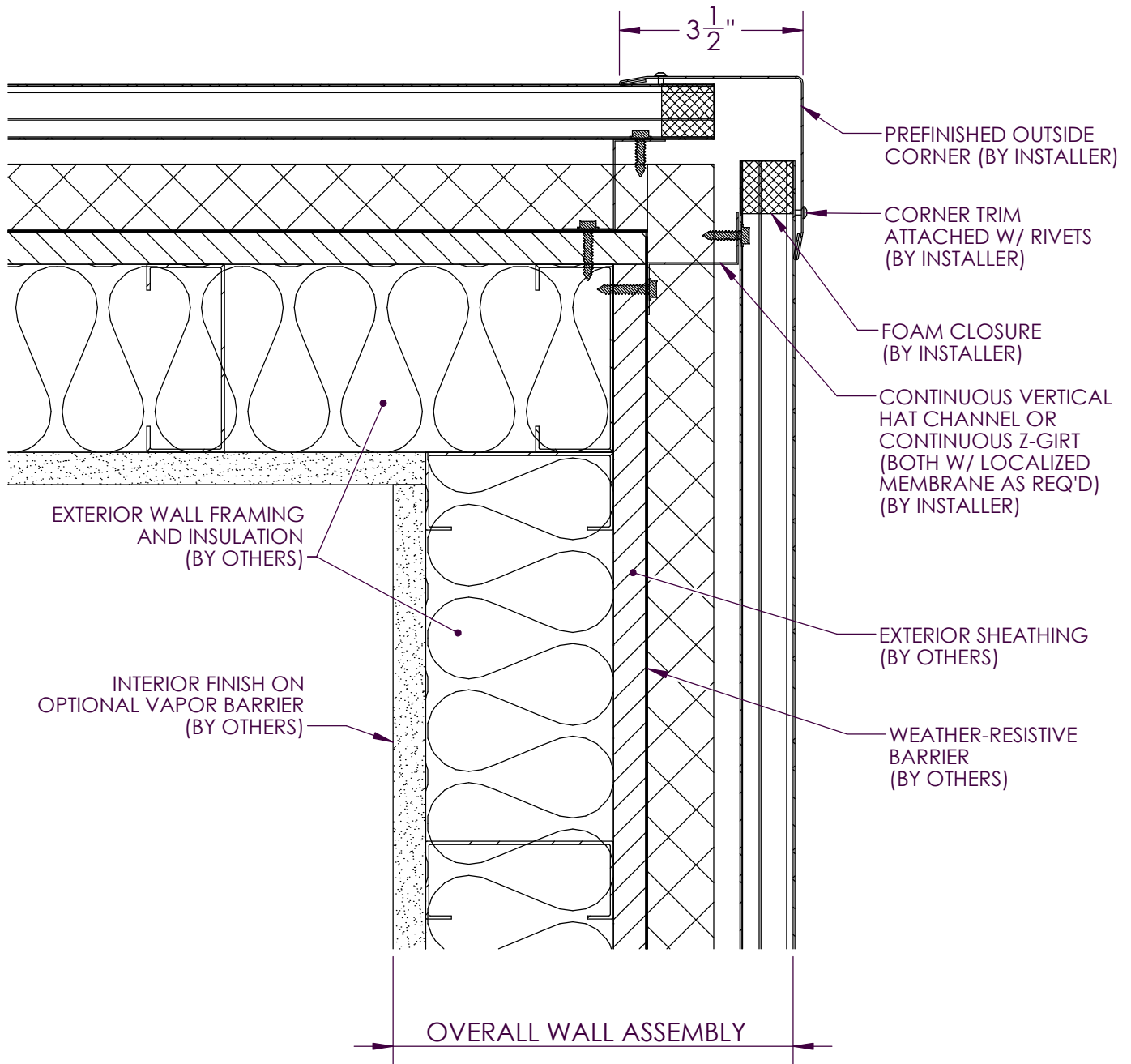



**WAARD
METALS**

ELEVATION SERIES

SOFFIT DETAIL
NO INSULATION

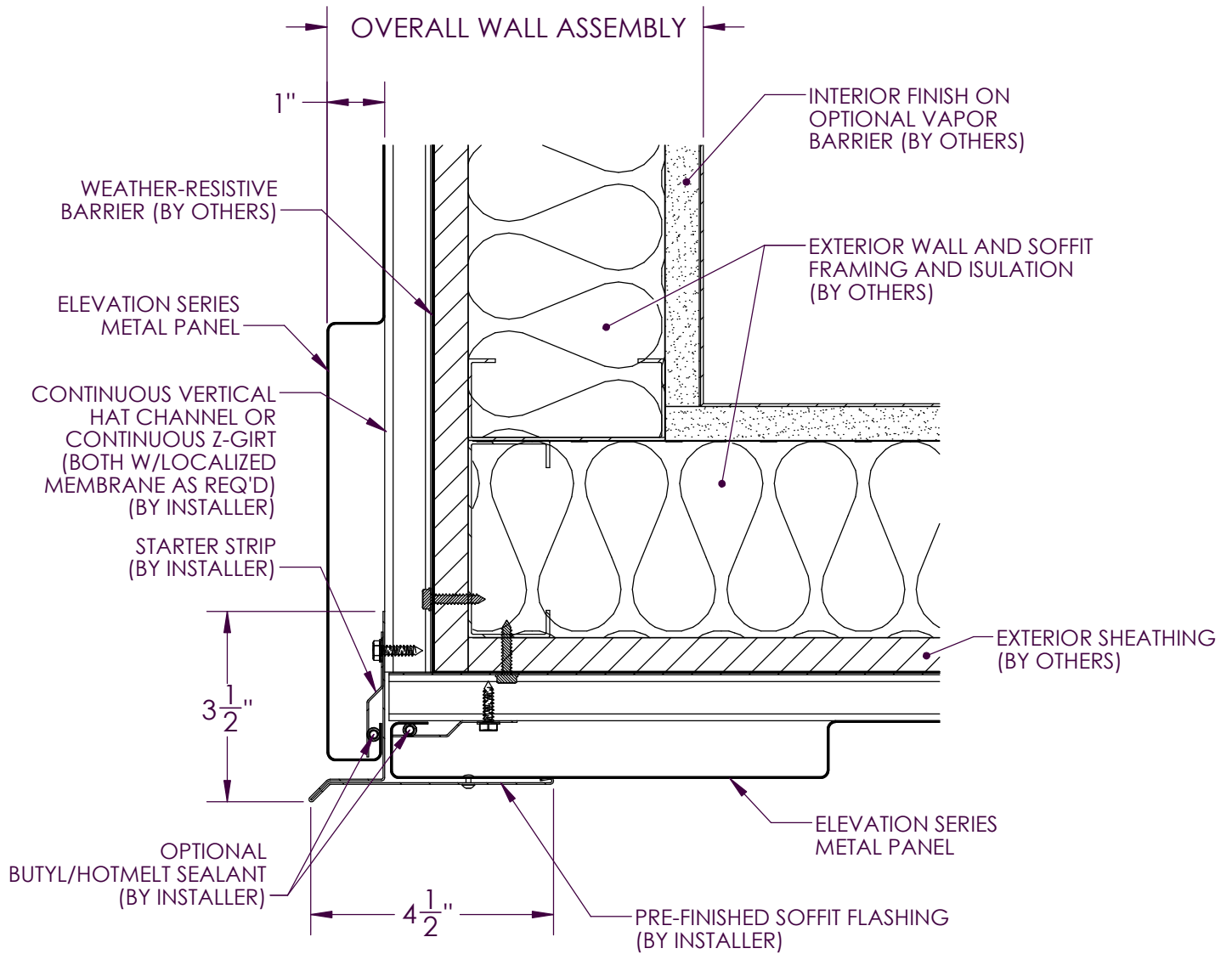



**WAARD
METALS**

ELEVATION SERIES

SOFFIT DETAIL
INSULATION

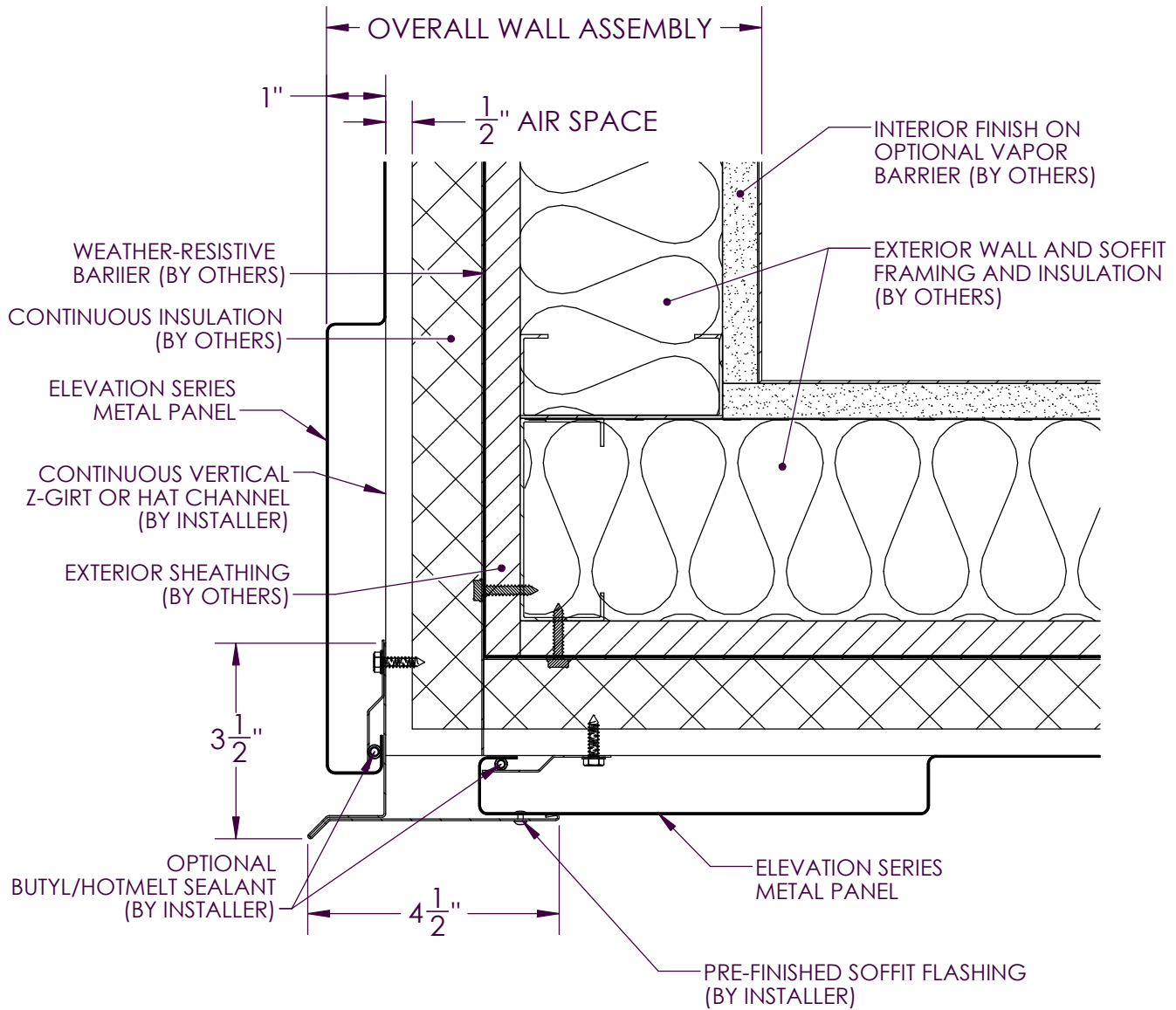



**WAARD
METALS**

ELEVATION SERIES

WINDOW HEAD
NO INSULATION

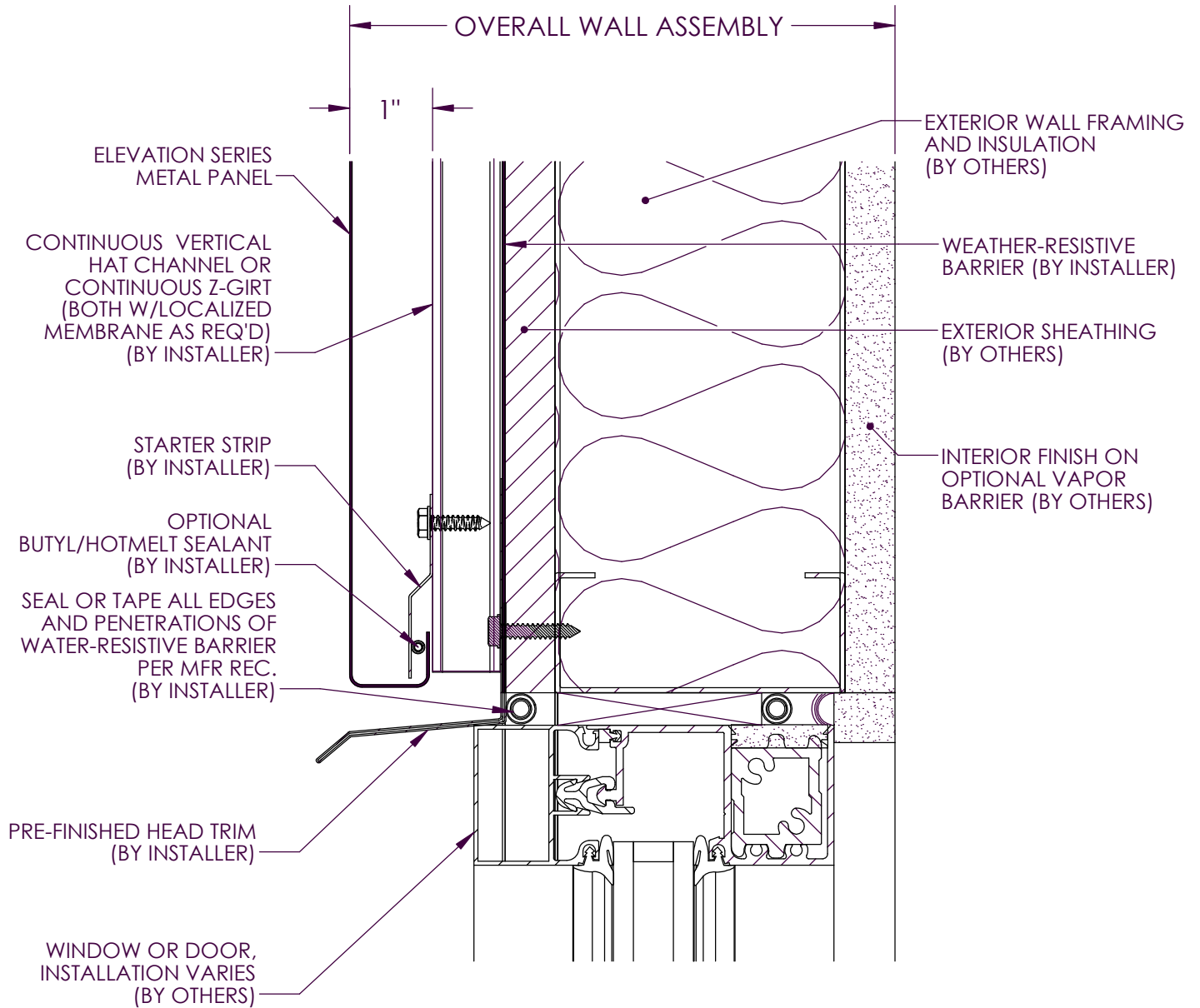



**WAARD
METALS**

ELEVATION SERIES

WINDOW HEAD DETAIL
INSULATION

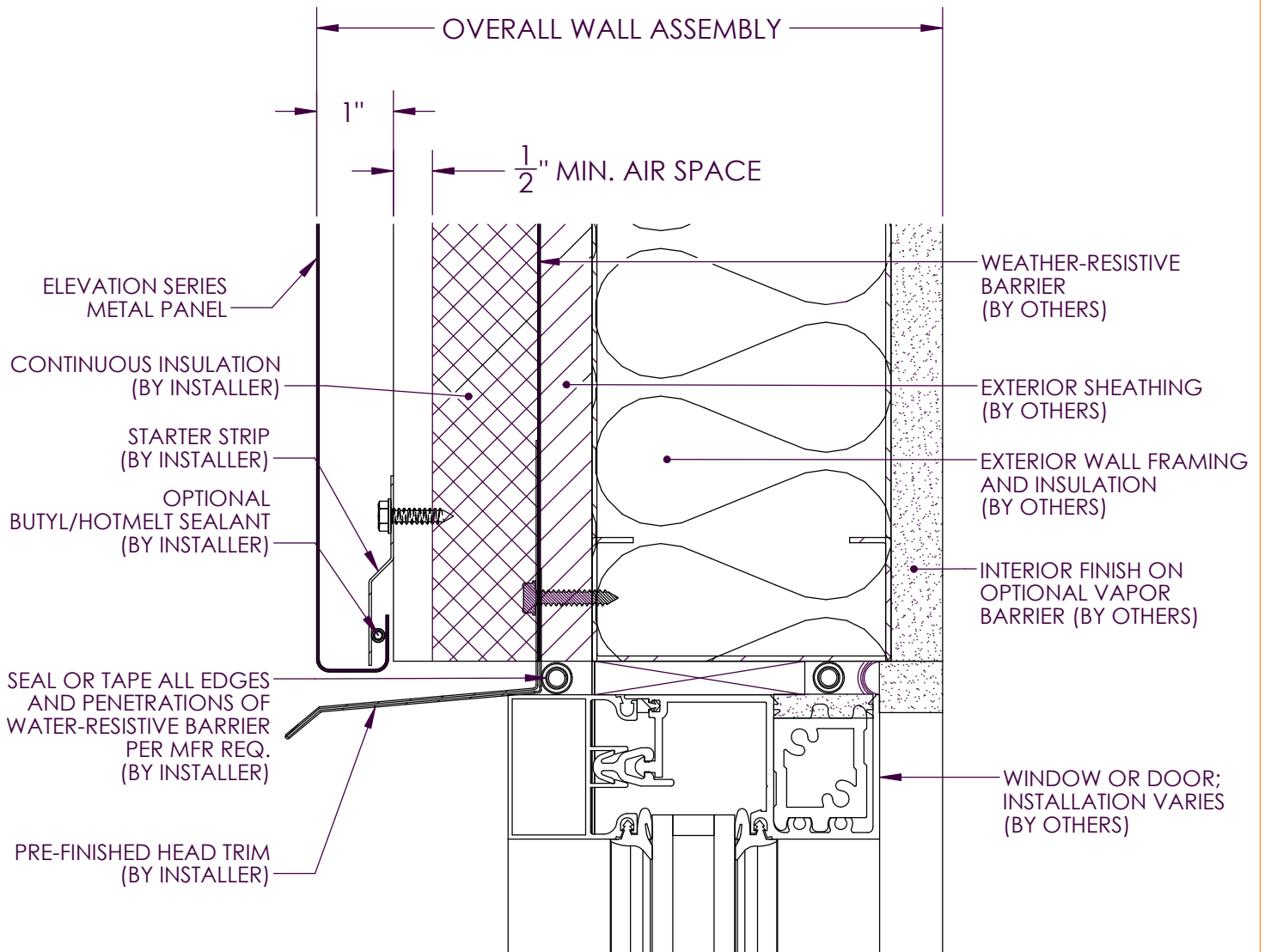



**WAARD
METALS**

ELEVATION SERIES

WINDOW JAMB DETAIL
NO INSULATION

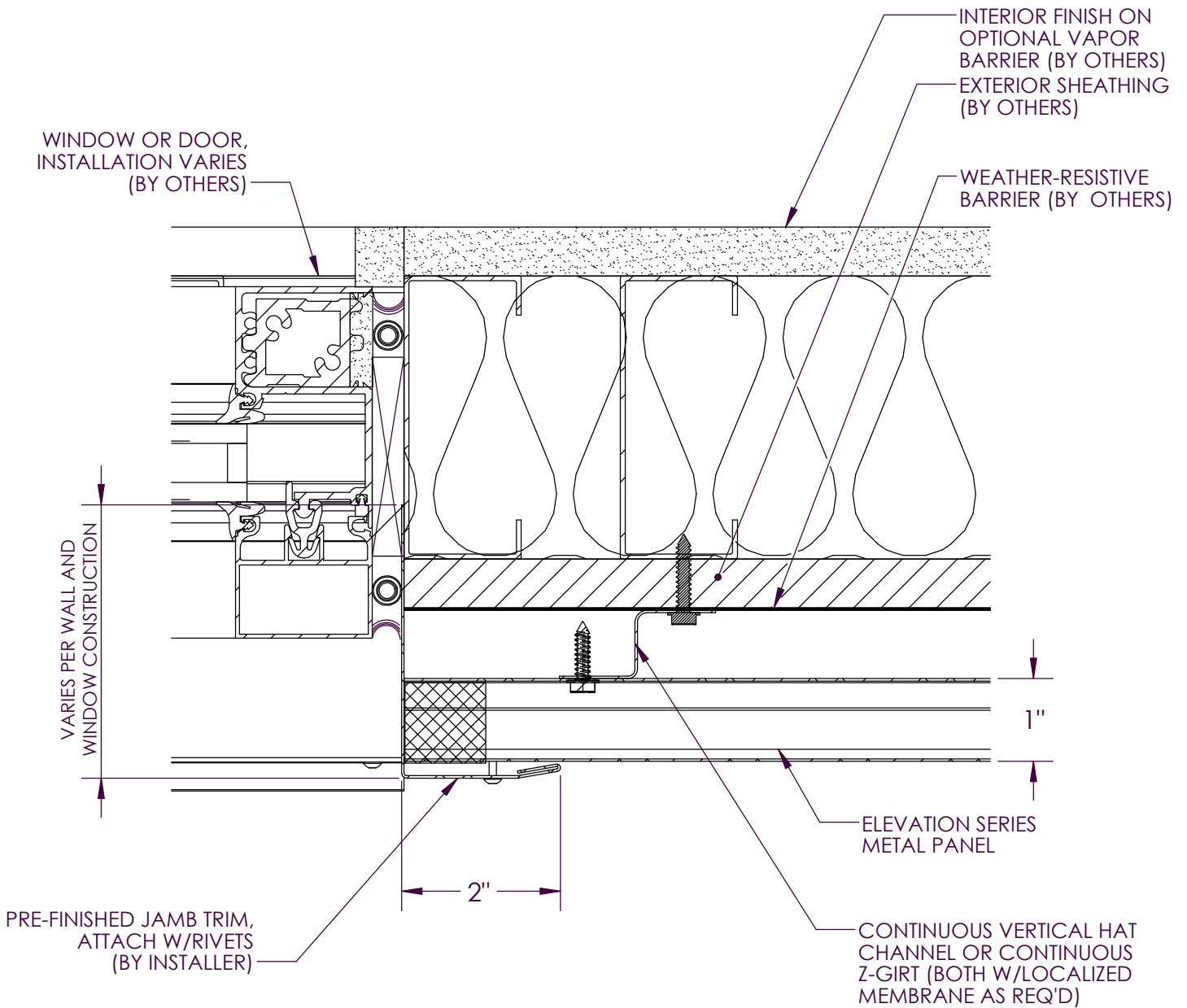



**WAARD
METALS**

ELEVATION SERIES

WINDOW JAMB DETAIL
INSULATION

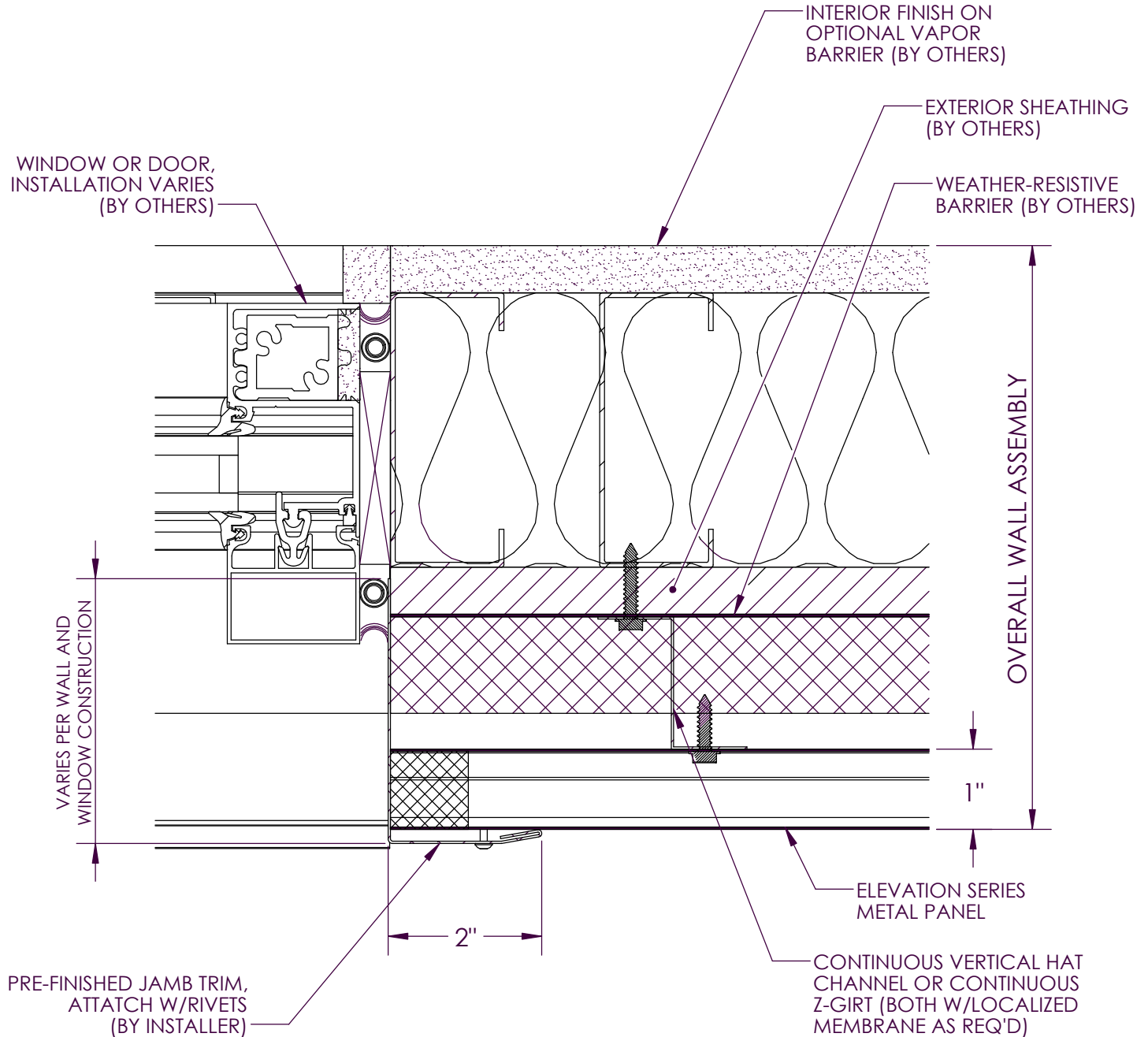



**WAARD
METALS**

ELEVATION SERIES

WINDOW SILL DETAIL
NO INSULATION

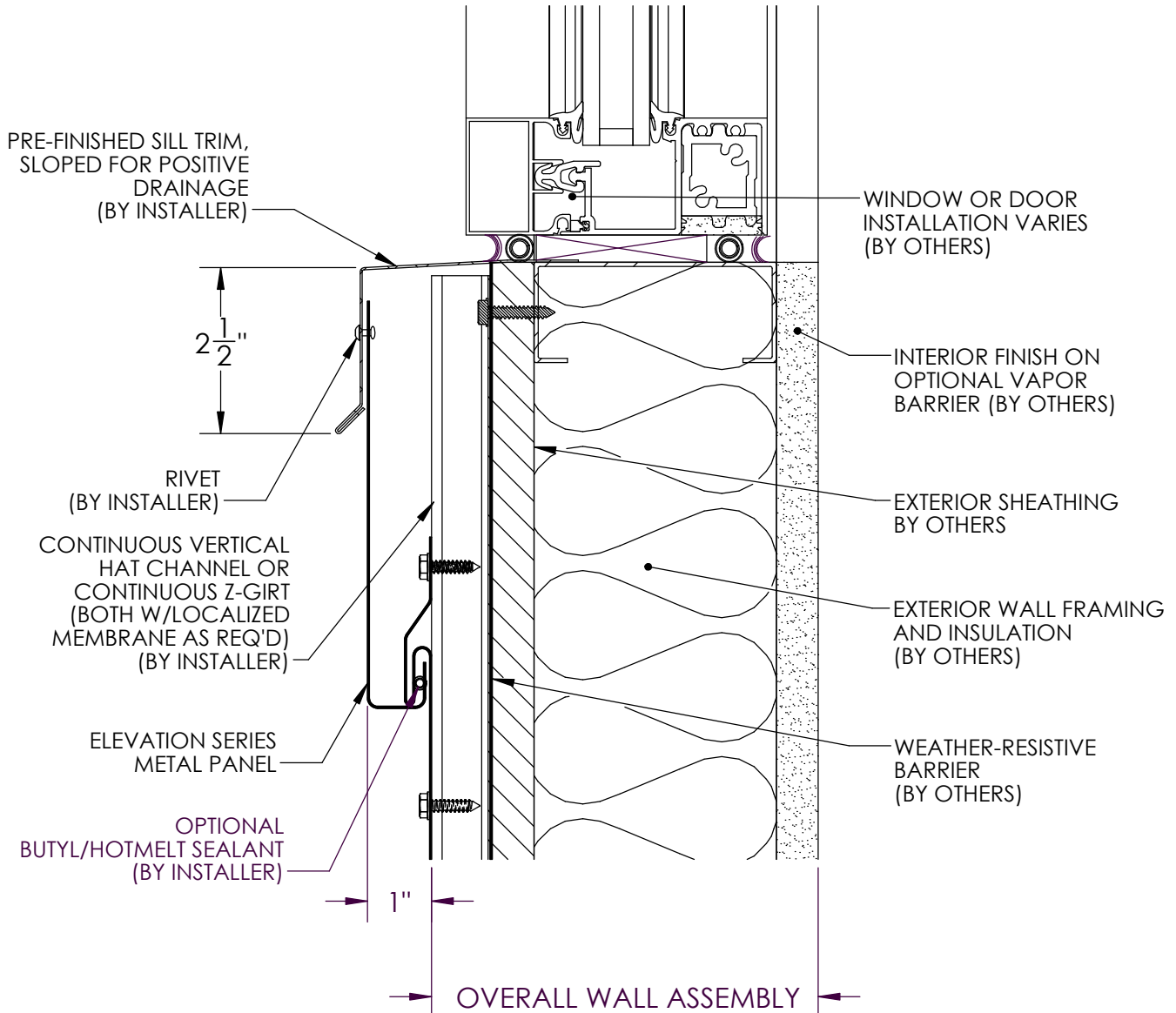



**WAARD
METALS**

ELEVATION SERIES

WINDOW SILL DETAIL
INSULATION

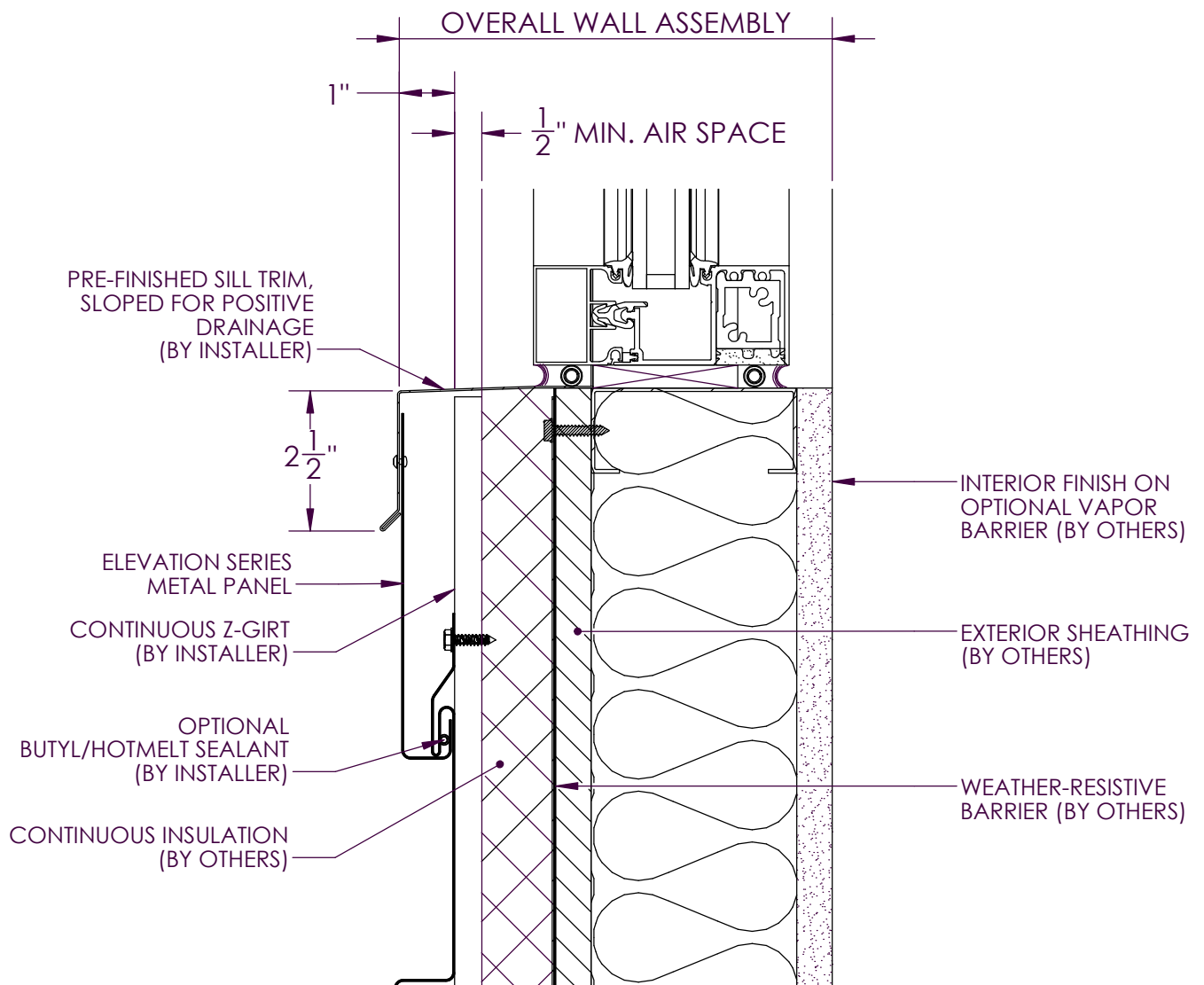



**WAARD
METALS**

ELEVATION SERIES

PANEL JOINT - LAP

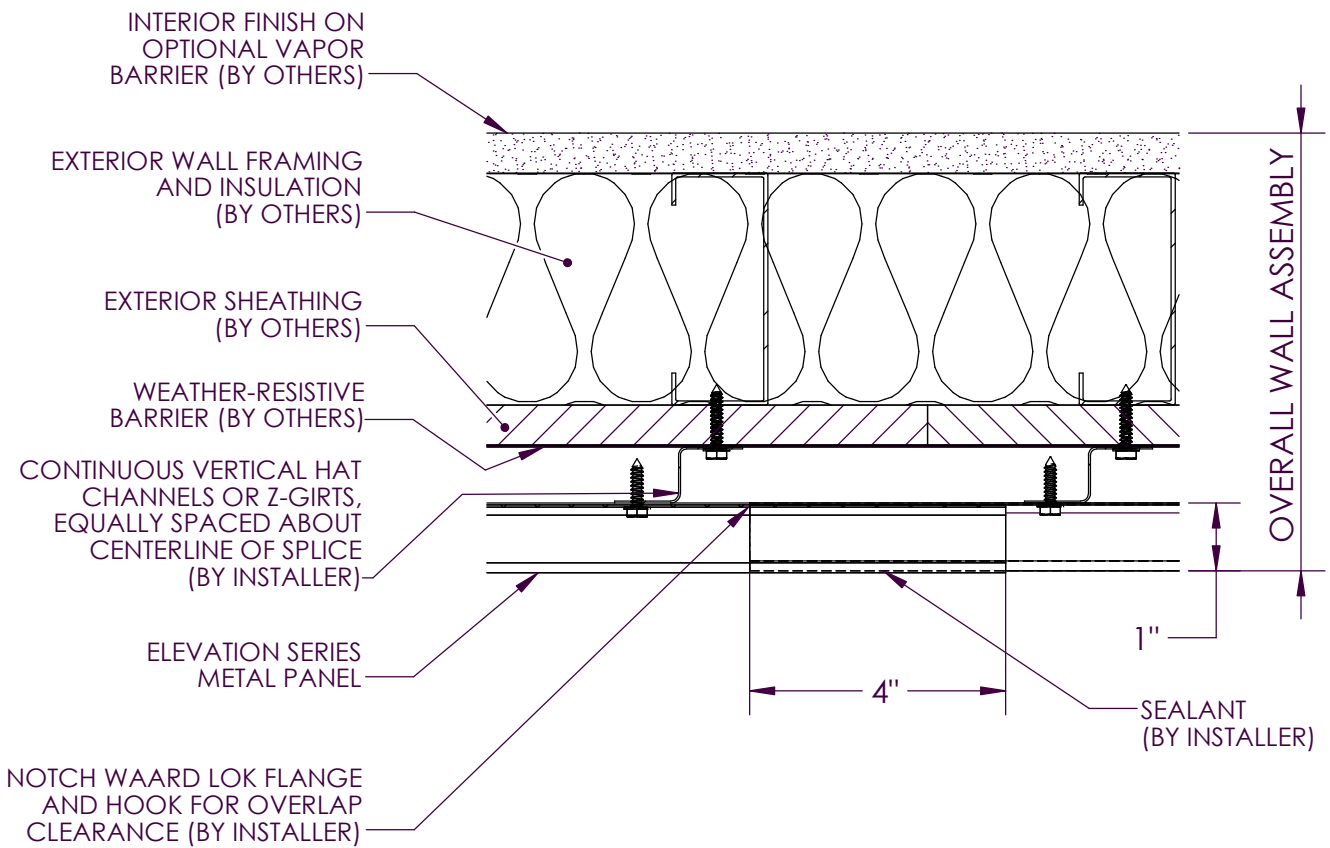



**WAARD
METALS**

ELEVATION SERIES

PANEL JOINT - SPLICE PLATE

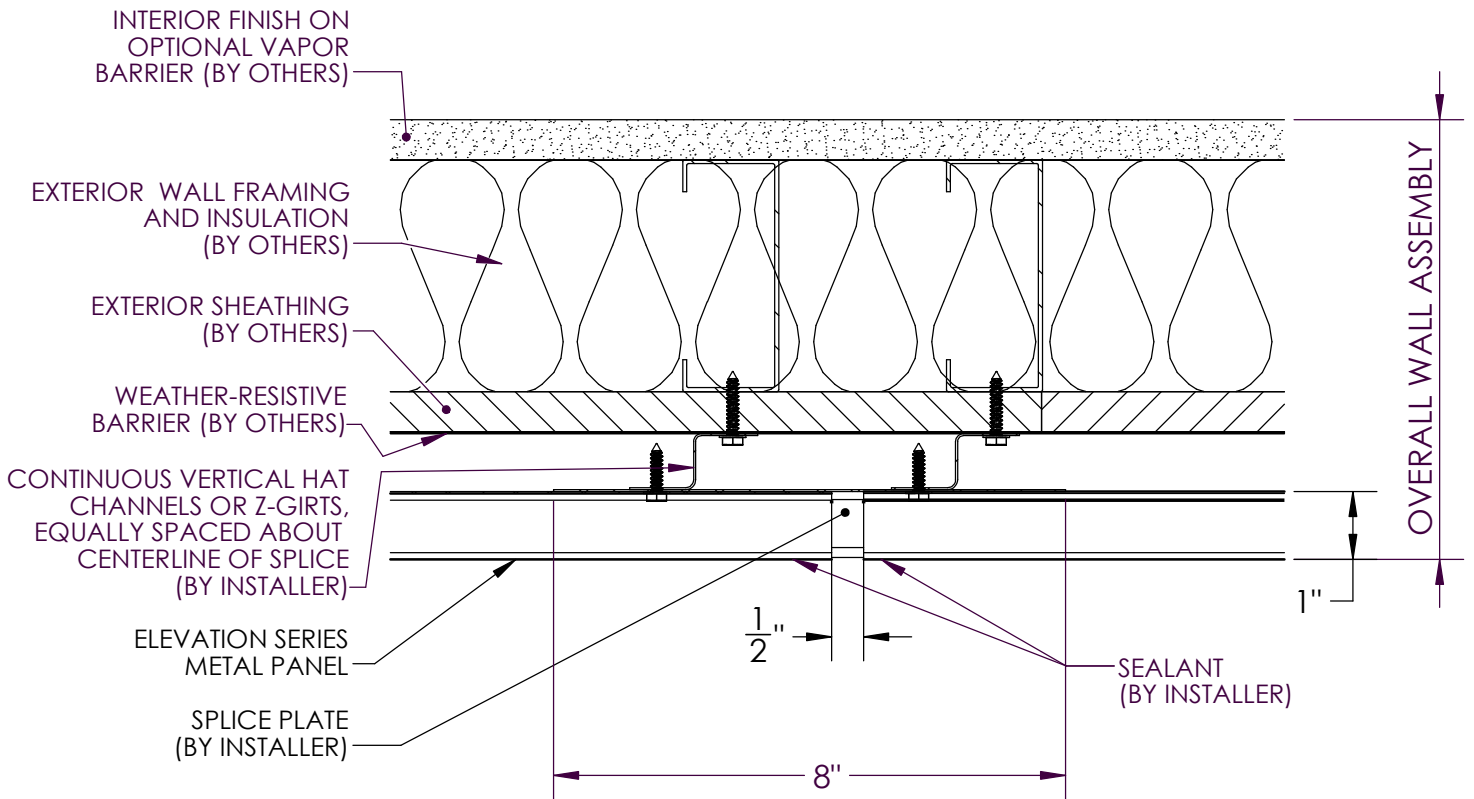



**WAARD
METALS**

ELEVATION SERIES

COVER TRIM DETAIL

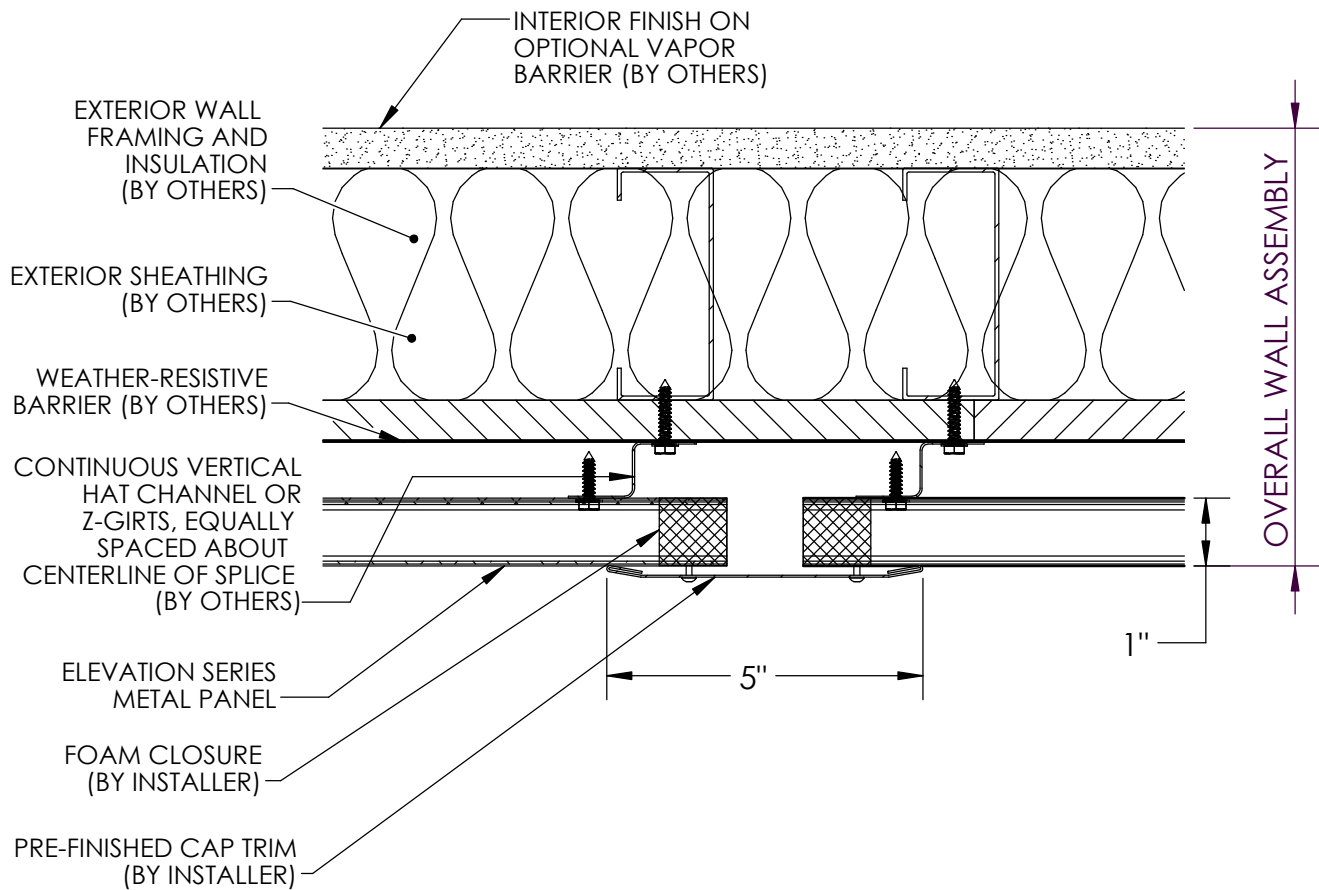



**WAARD
METALS**

ELEVATION SERIES

PANEL JOINT - J-CHANNEL

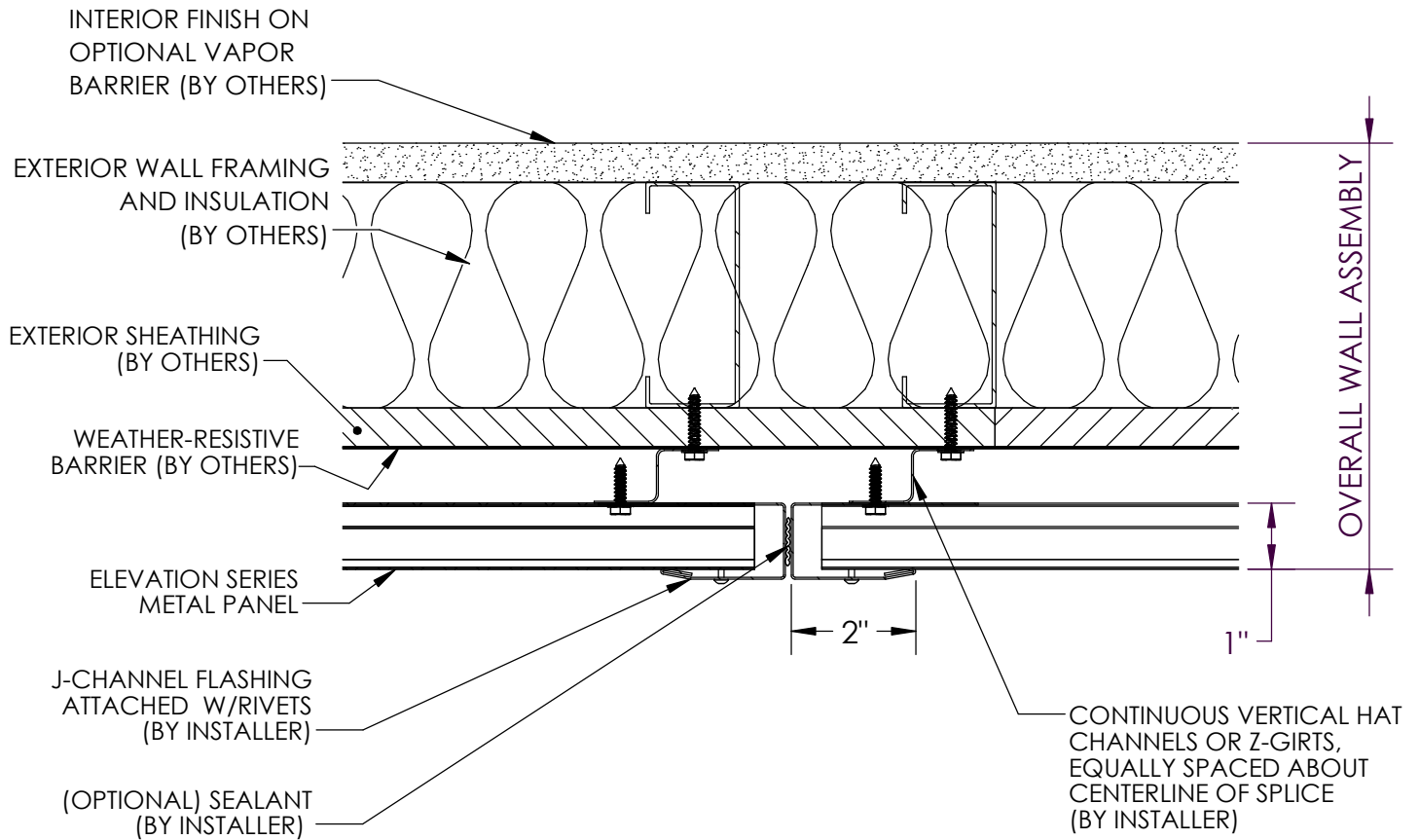



**WAARD
METALS**

ELEVATION SERIES

ISOMETRIC WALL
ASSEMBLY VIEW

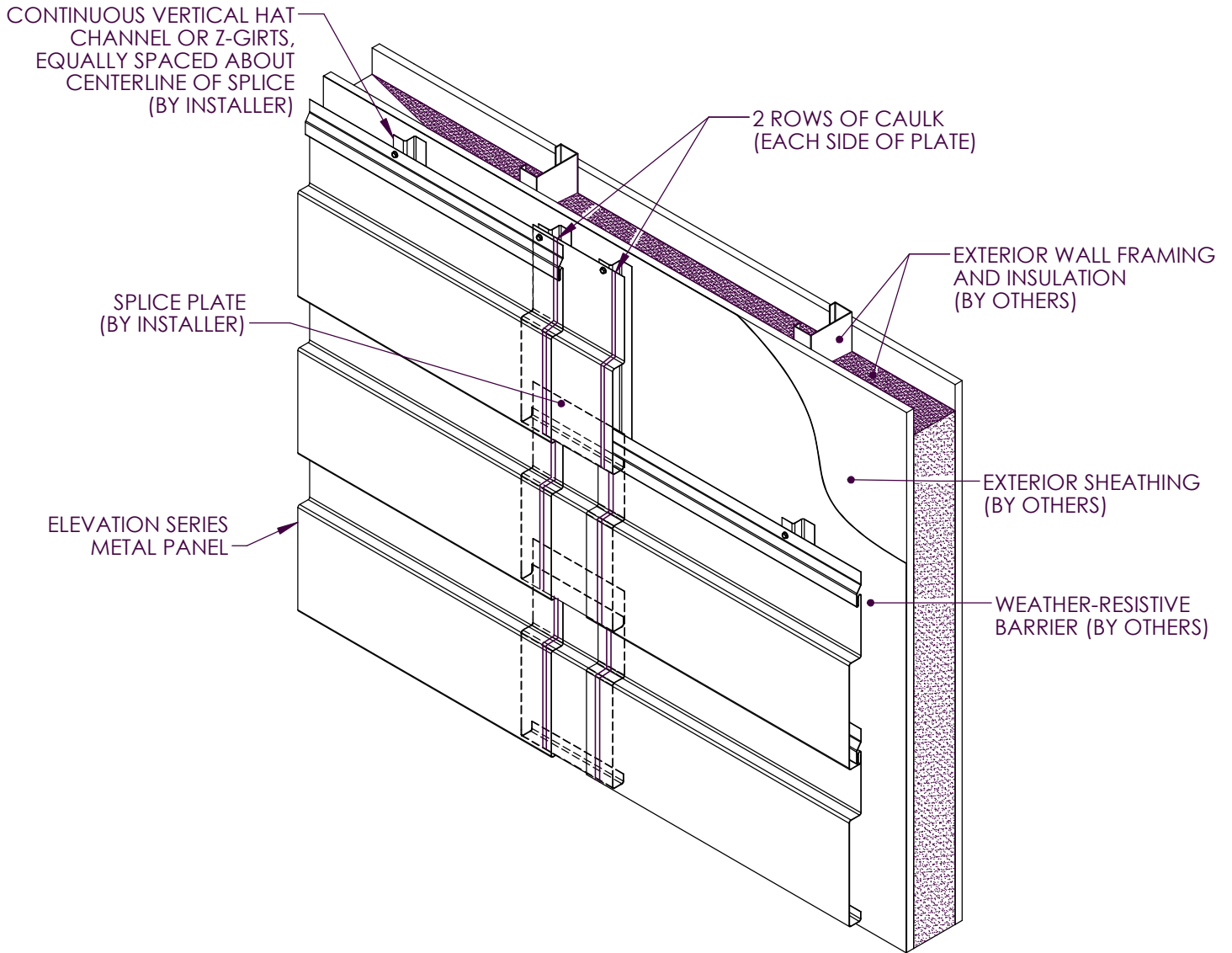



Z-GIRT AND HAT CHANNEL
PROFILE DIMENSIONS:

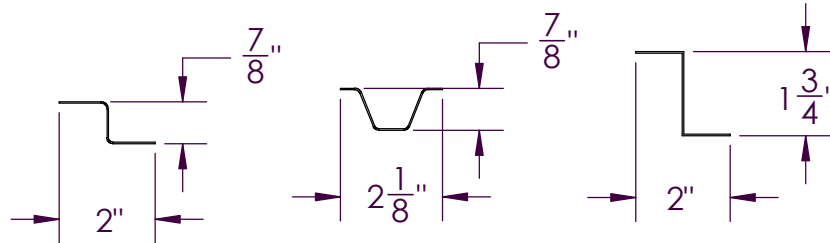

WINDOW JAMB
TRIM

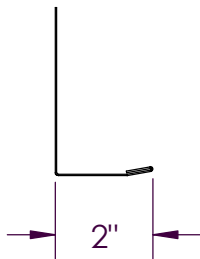

SILL TRIM

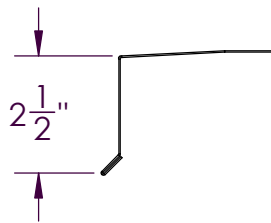

SOFFIT TRIM

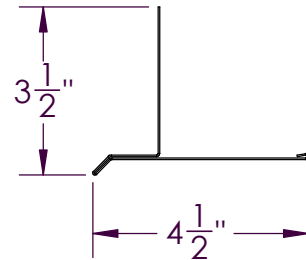

OUTSIDE CORNER

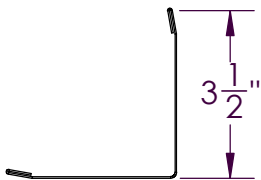

INSIDE CORNER

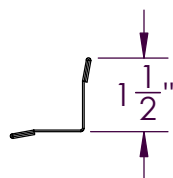

J-CHANNEL

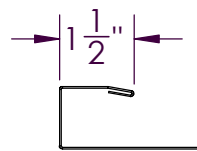

CAP TRIM

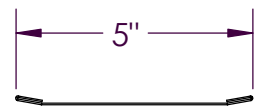

BASE TRIM /
WINDOW HEAD TRIM

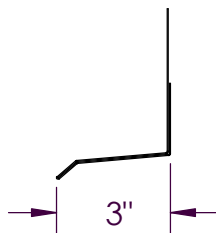

STARTER STRIP

