

PAGE NUMBER	DESCRIPTION
2-3	PINNACLE PANEL DETAILS
4, 5	BASE DETAIL
6-8	HORIZONTAL JOINT DETAIL
9, 10	PARAPET DETAIL
11, 12	INSIDE CORNER DETAIL
13, 14	OUTSIDE CORNER DETAIL
15, 16	SOFFIT DETAIL
17, 18	WINDOW HEAD DETAIL
19, 20	WINDOW JAMB DETAIL
21, 22	WINDOW SILL DETAIL
23-26	PANEL JOINT DETAIL
27	ISOMETRIC WALL ASSEMBLY
28	TRIM PROFILE DETAILS



**WAARD
METALS**

PINNACLE SERIES

PS-12

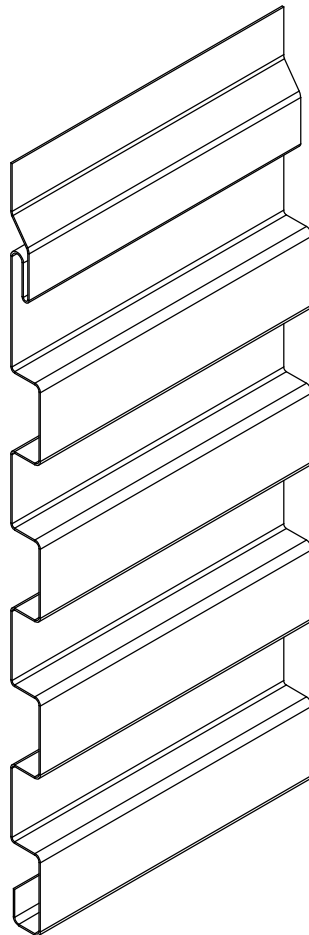
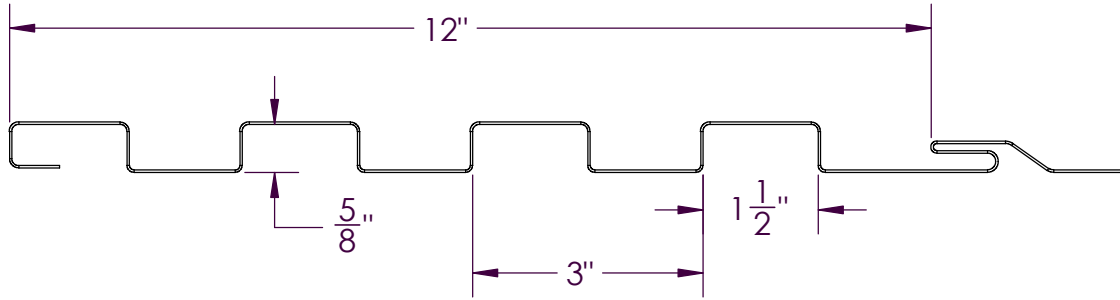



**WAARD
METALS**

PINNACLE SERIES

PS-16

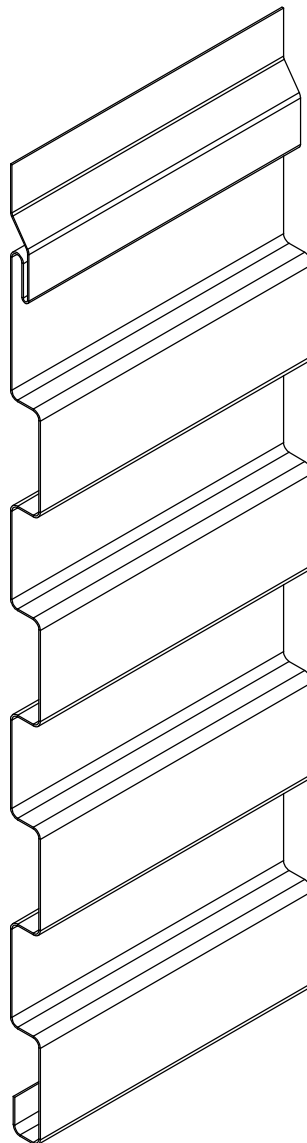
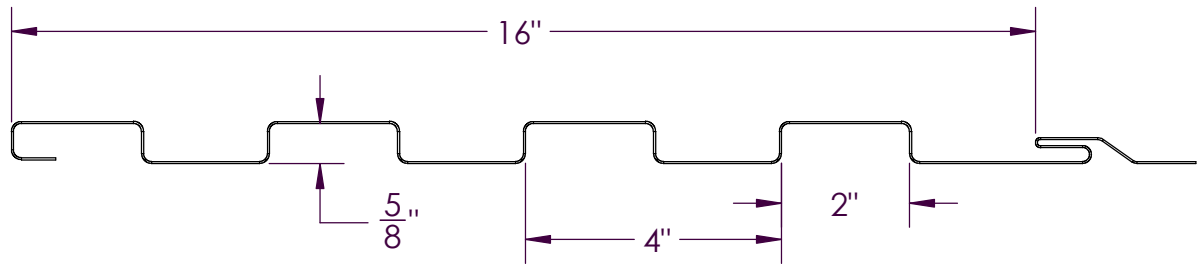



**WAARD
METALS**

PINNACLE SERIES

WALL BASE DETAIL
INSULATION

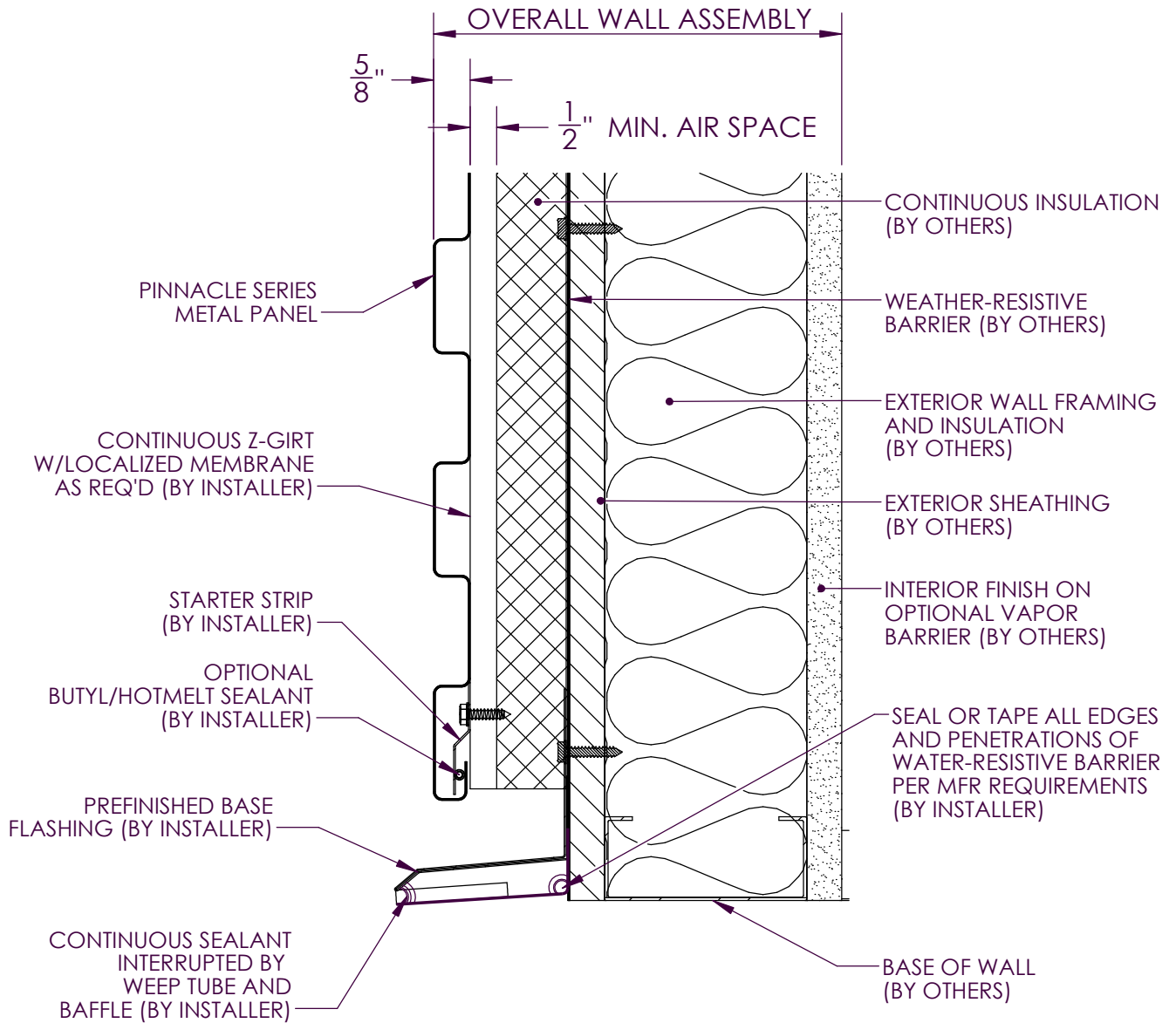



**WAARD
METALS**

PINNACLE SERIES

BASE DETAIL
NO INSULATION

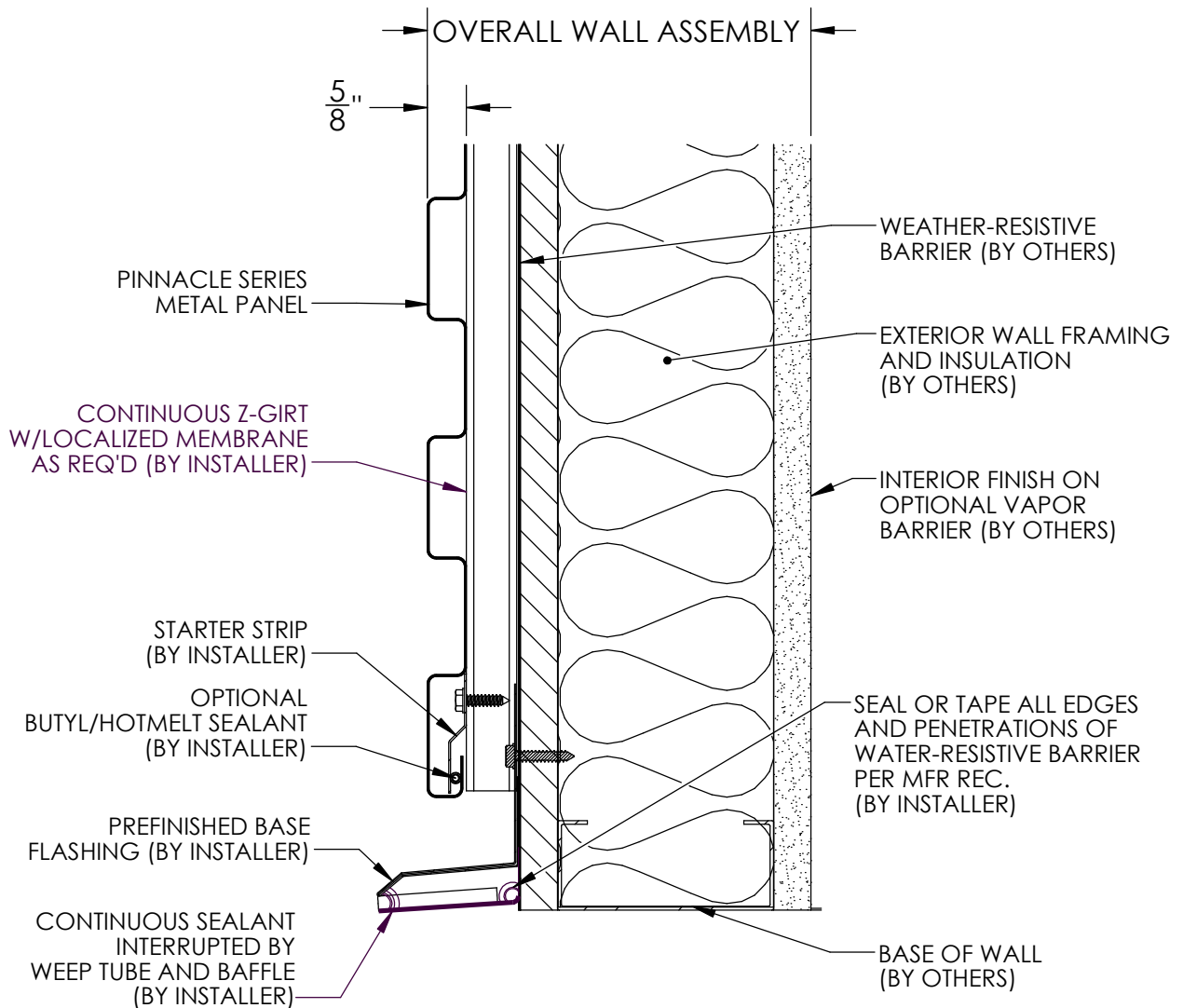



**WAARD
METALS**

PINNACLE SERIES

HORIZONTAL JOINT DETAIL
NO INSULATION

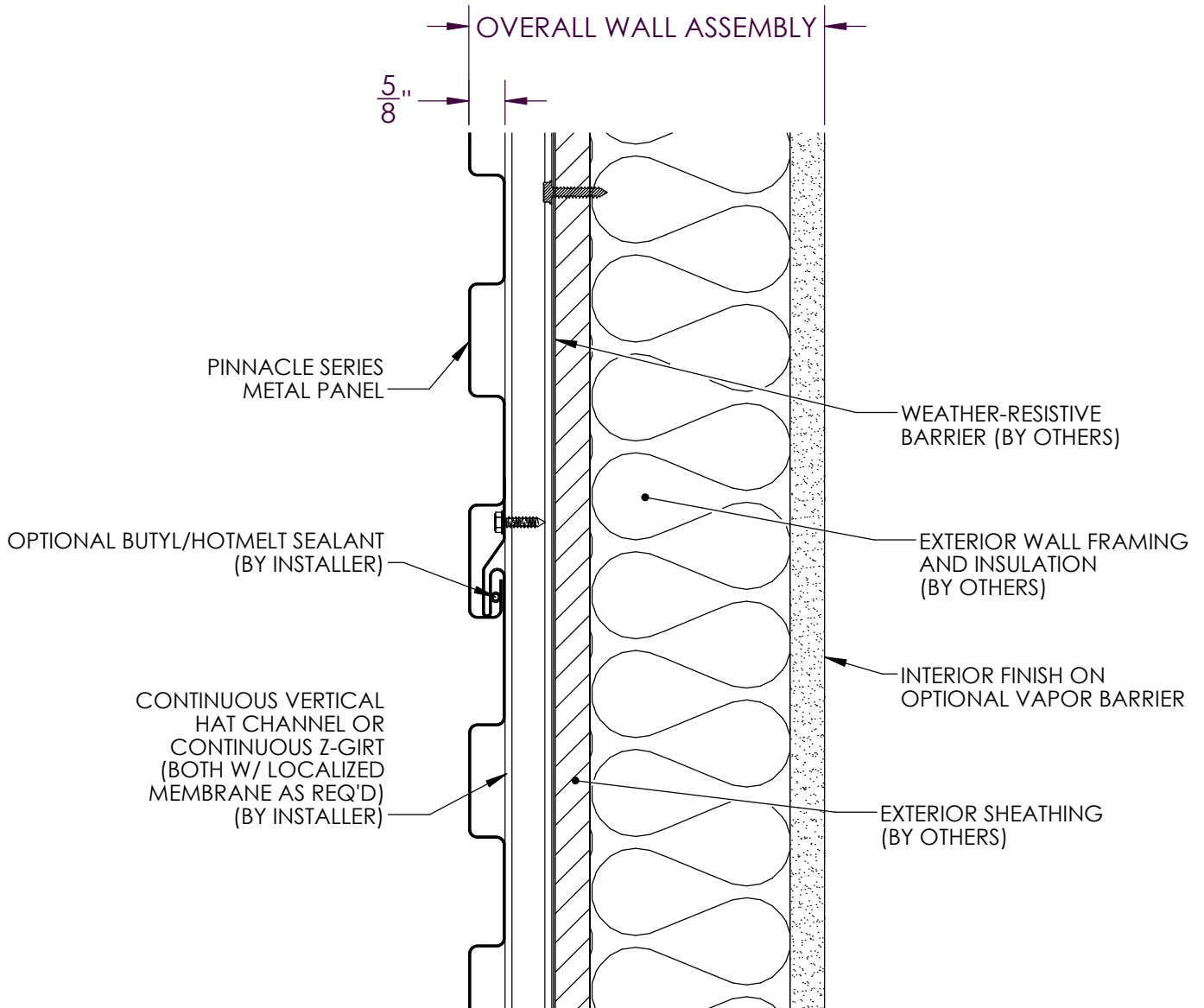



**WAARD
METALS**

PINNACLE SERIES

HORIZONTAL JOINT DETAIL
INSULATION

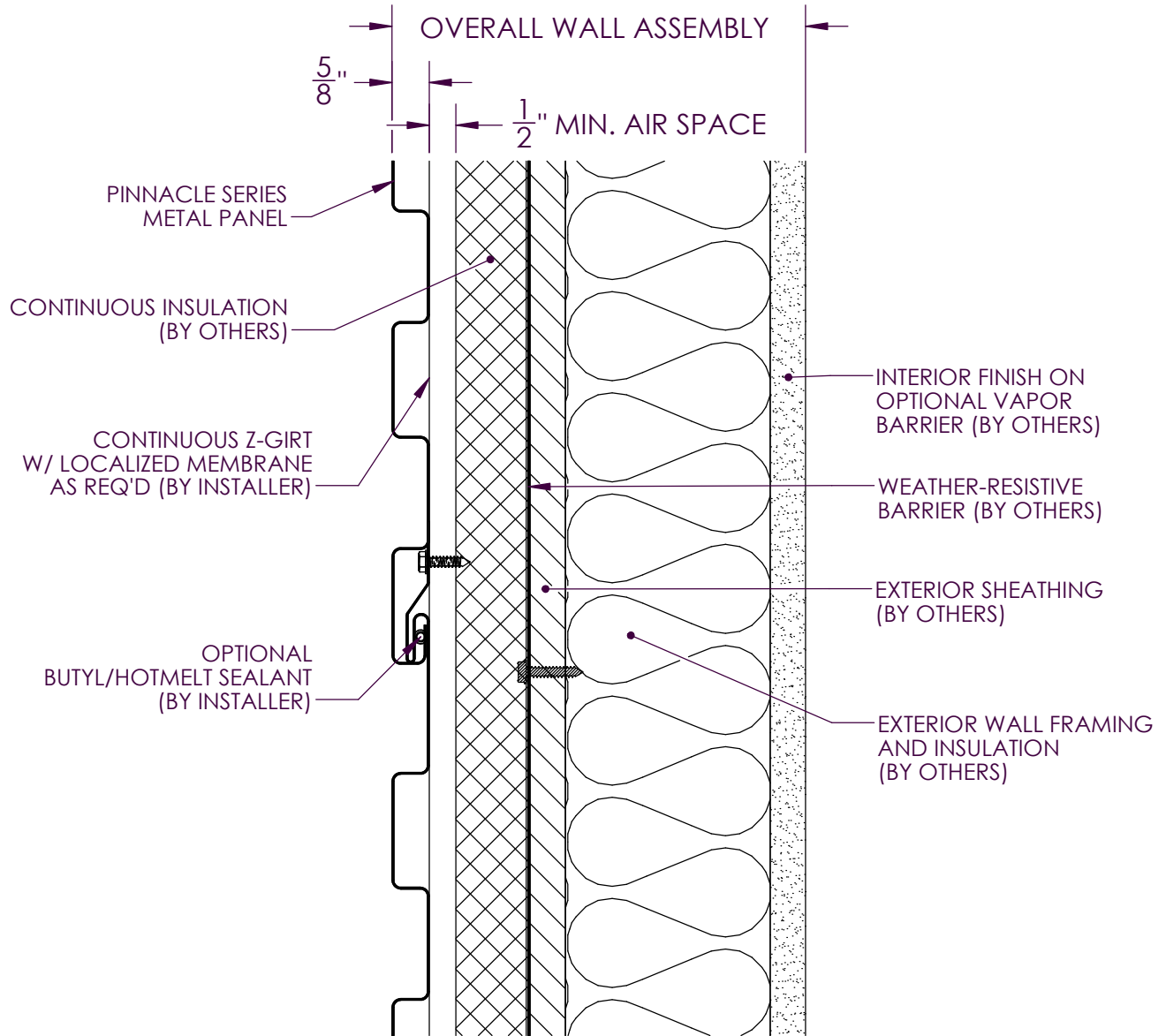



**WAARD
METALS**

PINNACLE SERIES

HORIZONTAL JOINT DETAIL
DIRECT FASTEN OPTION

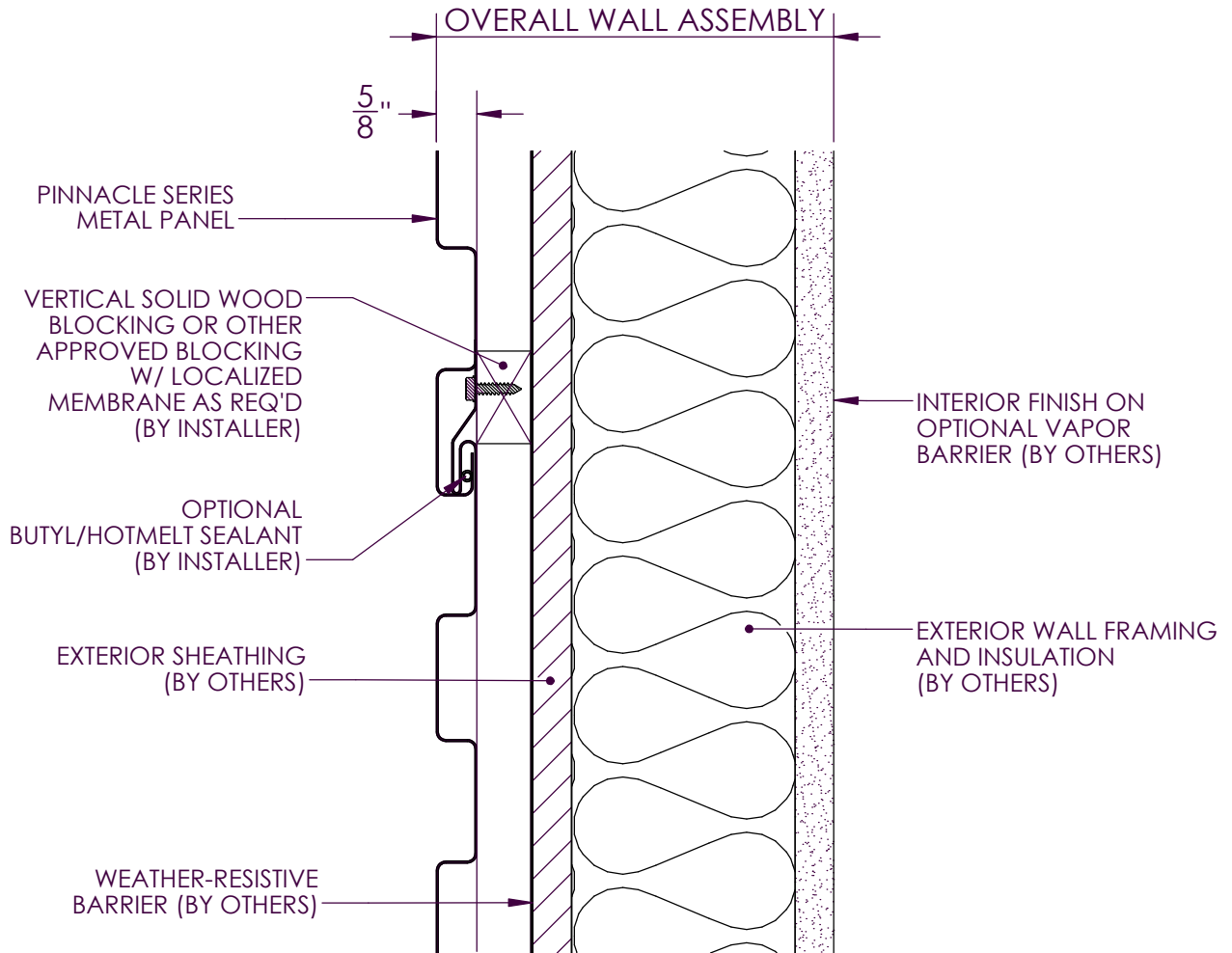



**WAARD
METALS**

PINNACLE SERIES

PARAPET ROOF DETAIL
NO INSULATION

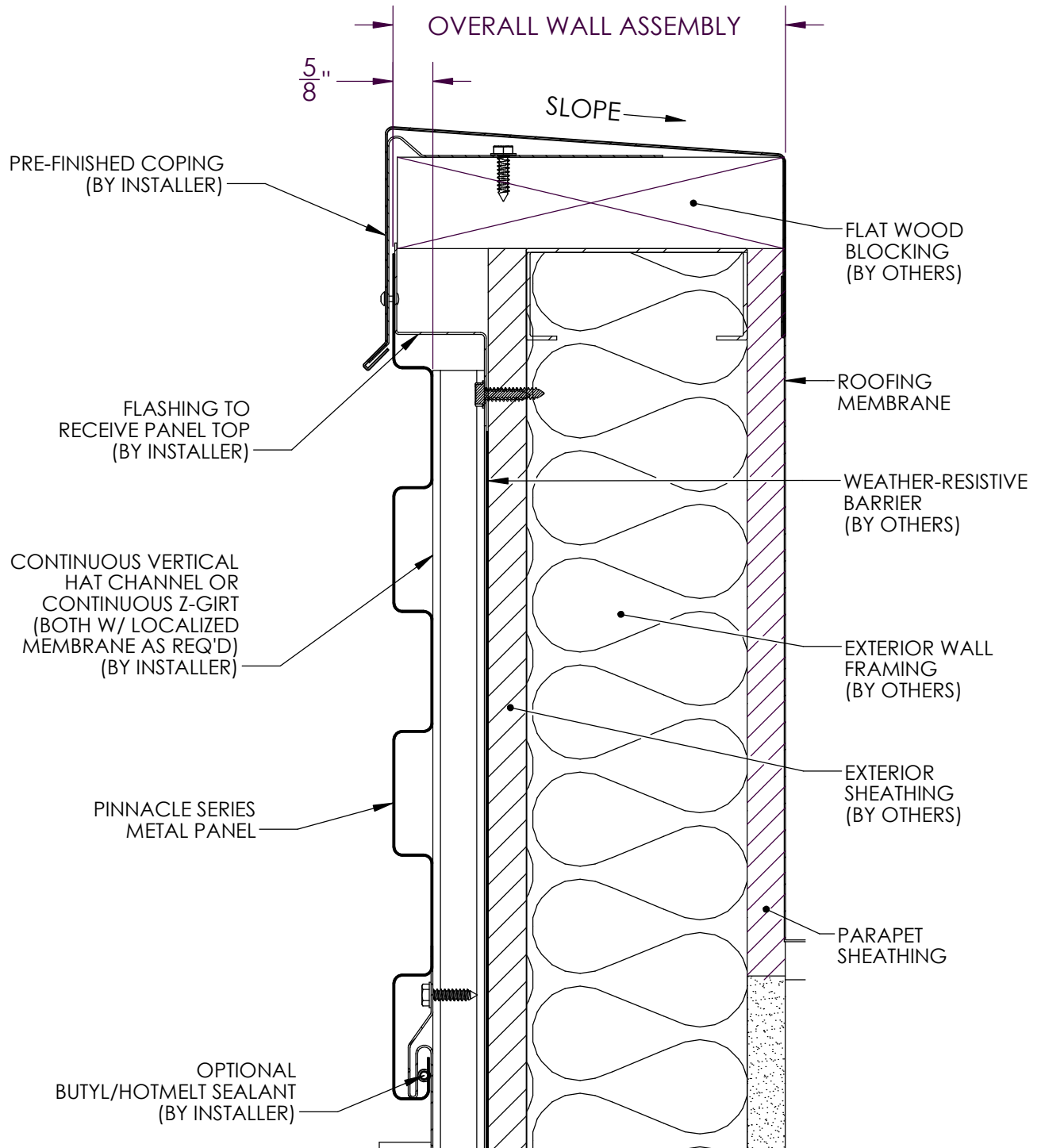



**WAARD
METALS**

PINNACLE SERIES

PARAPET ROOF DETAIL
INSULATION

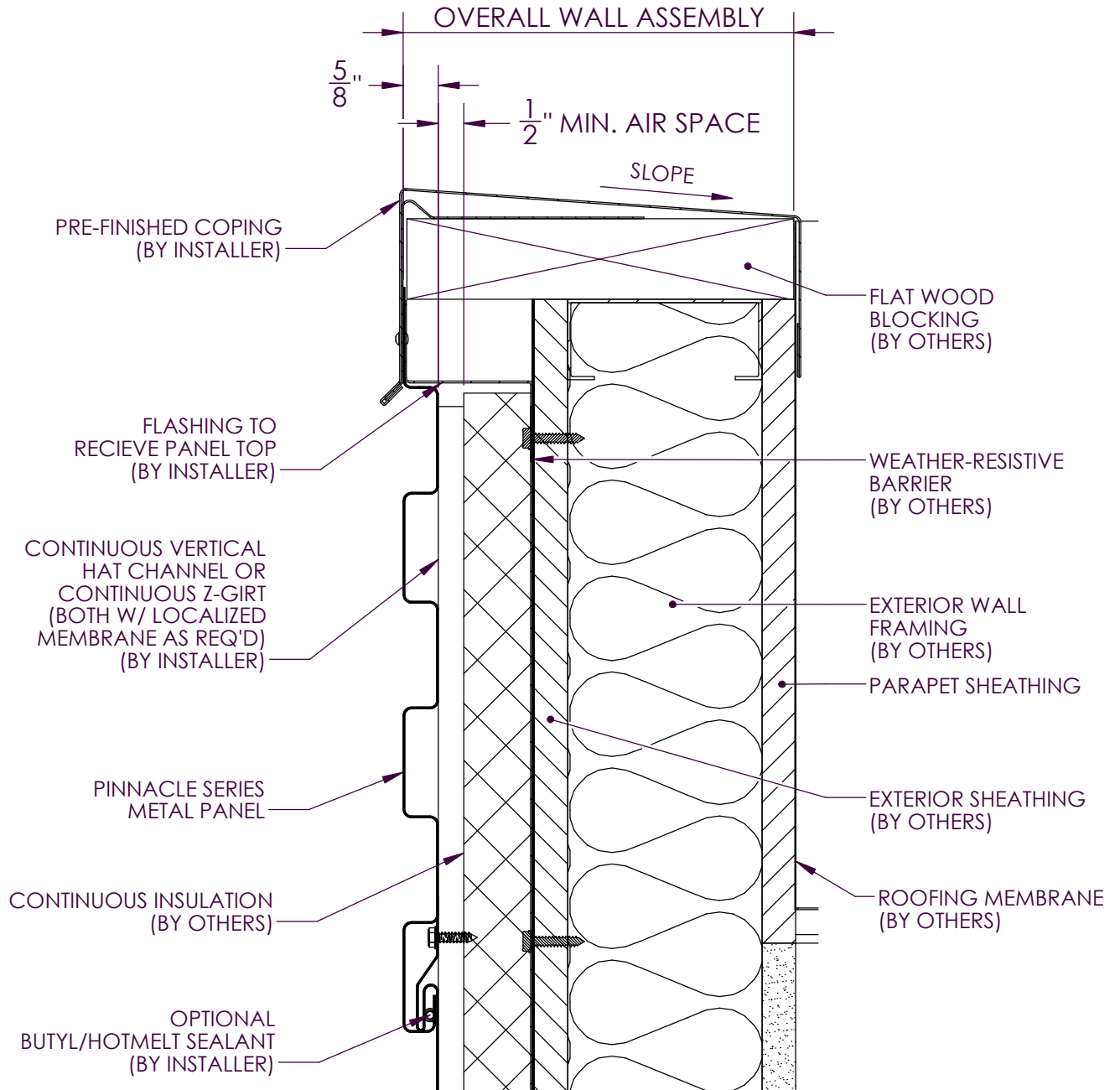



**WAARD
METALS**

PINNACLE SERIES

INSIDE CORNER DETAIL
NO INSULATION

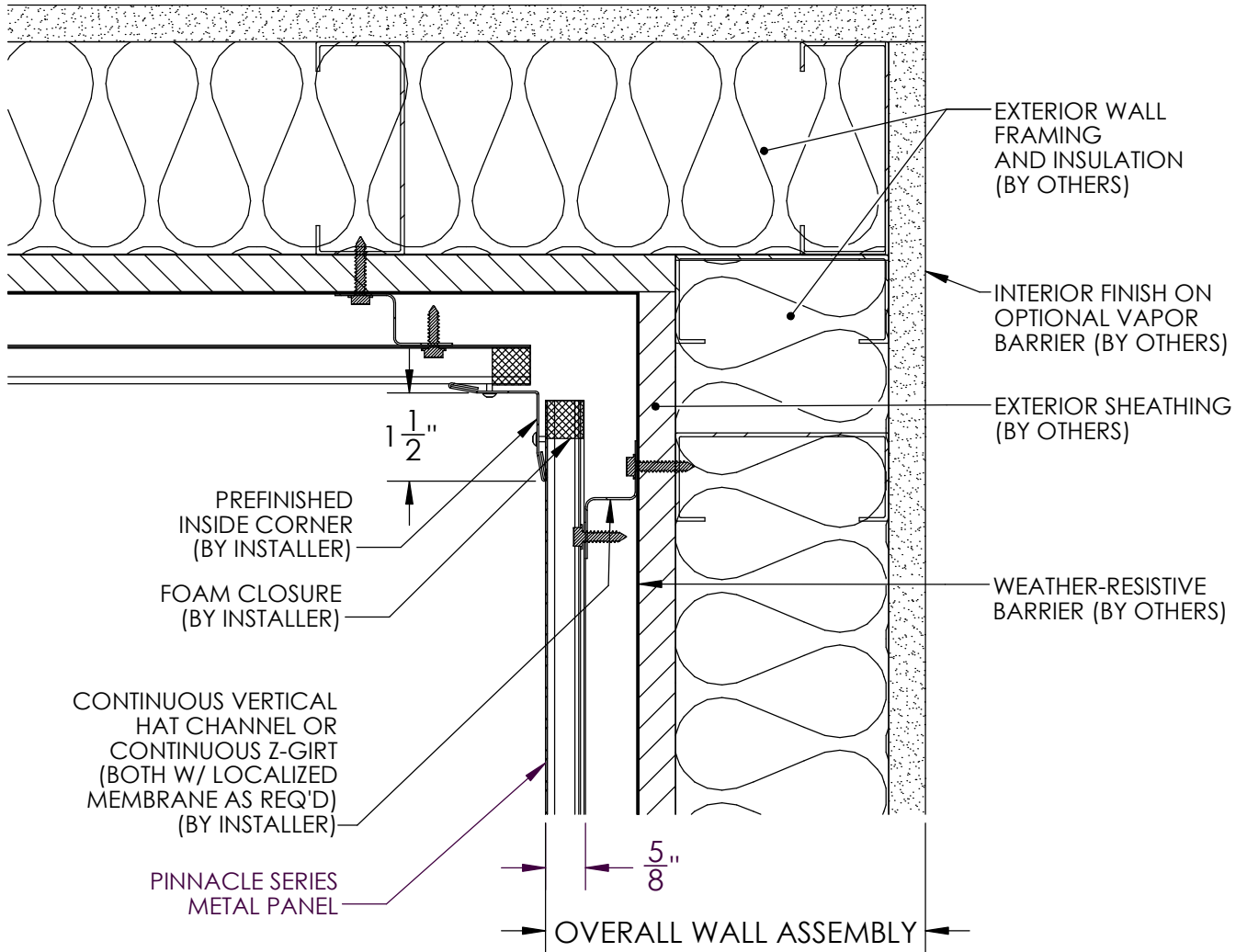



**WAARD
METALS**

PINNACLE SERIES

INSIDE CORNER DETAIL
INSULATION

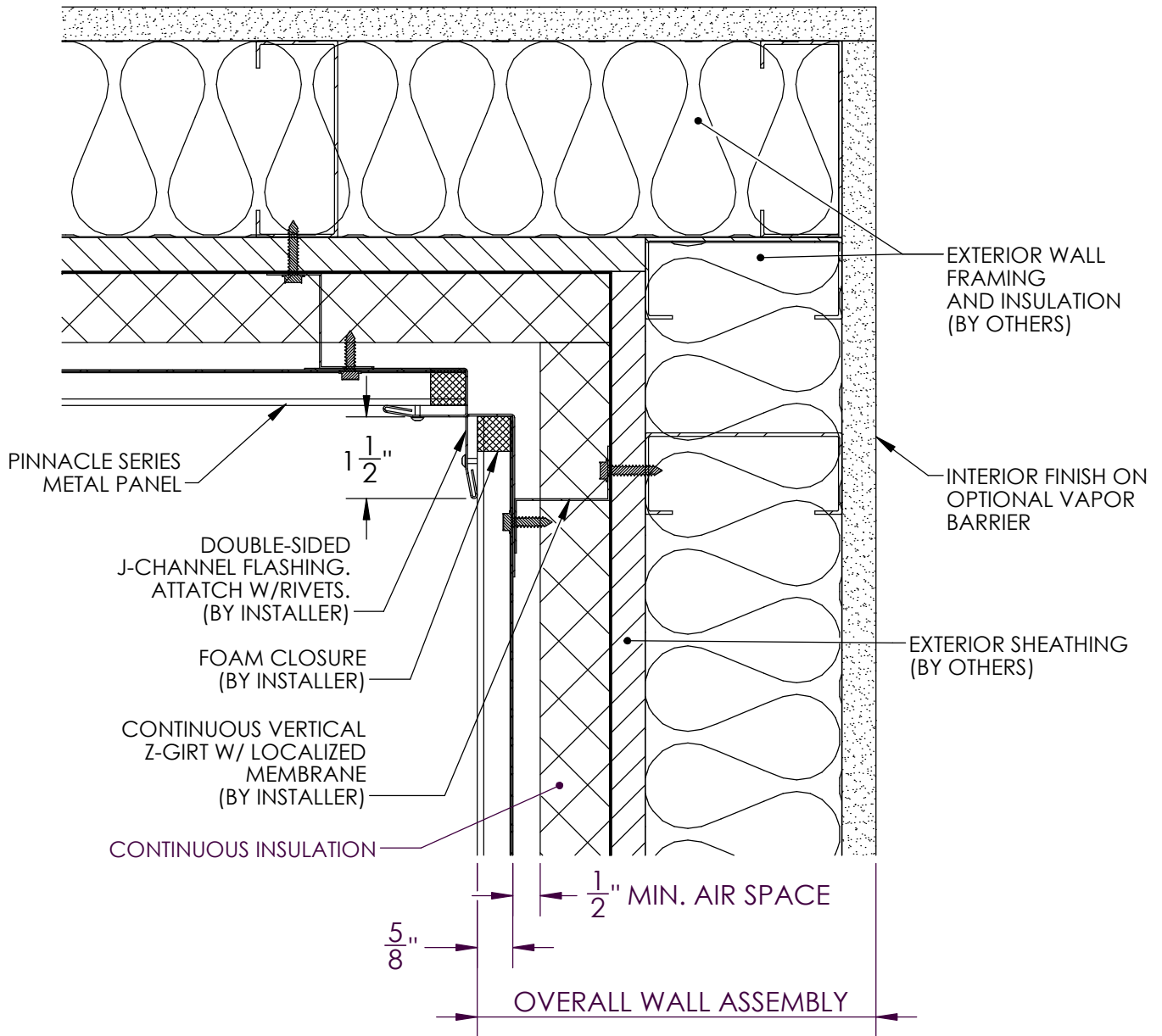



**WAARD
METALS**

PINNACLE SERIES

OUTSIDE CORNER
NO INSULATION

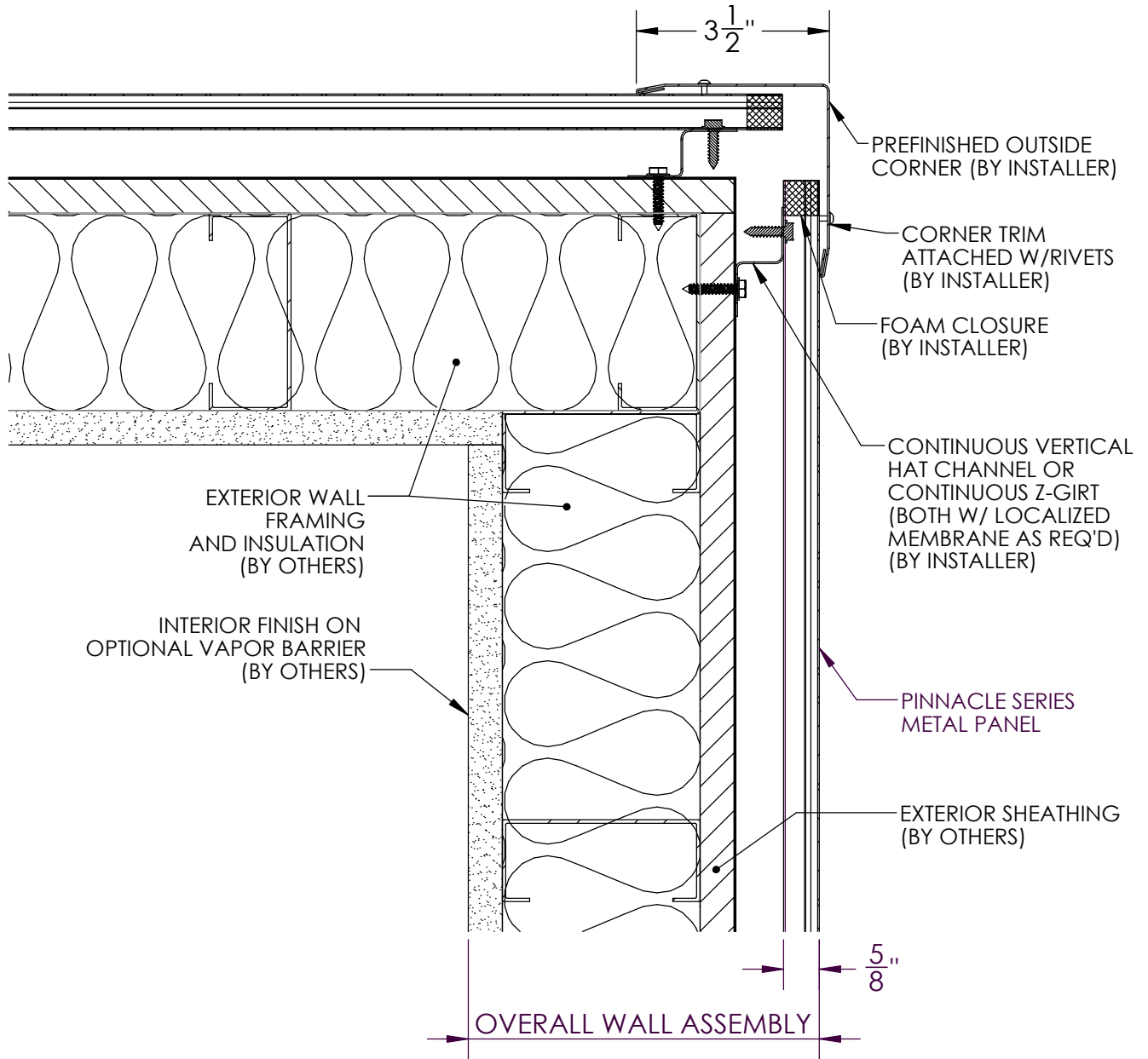



**WAARD
METALS**

PINNACLE SERIES

OUTSIDE CORNER DETAIL
INSULATION

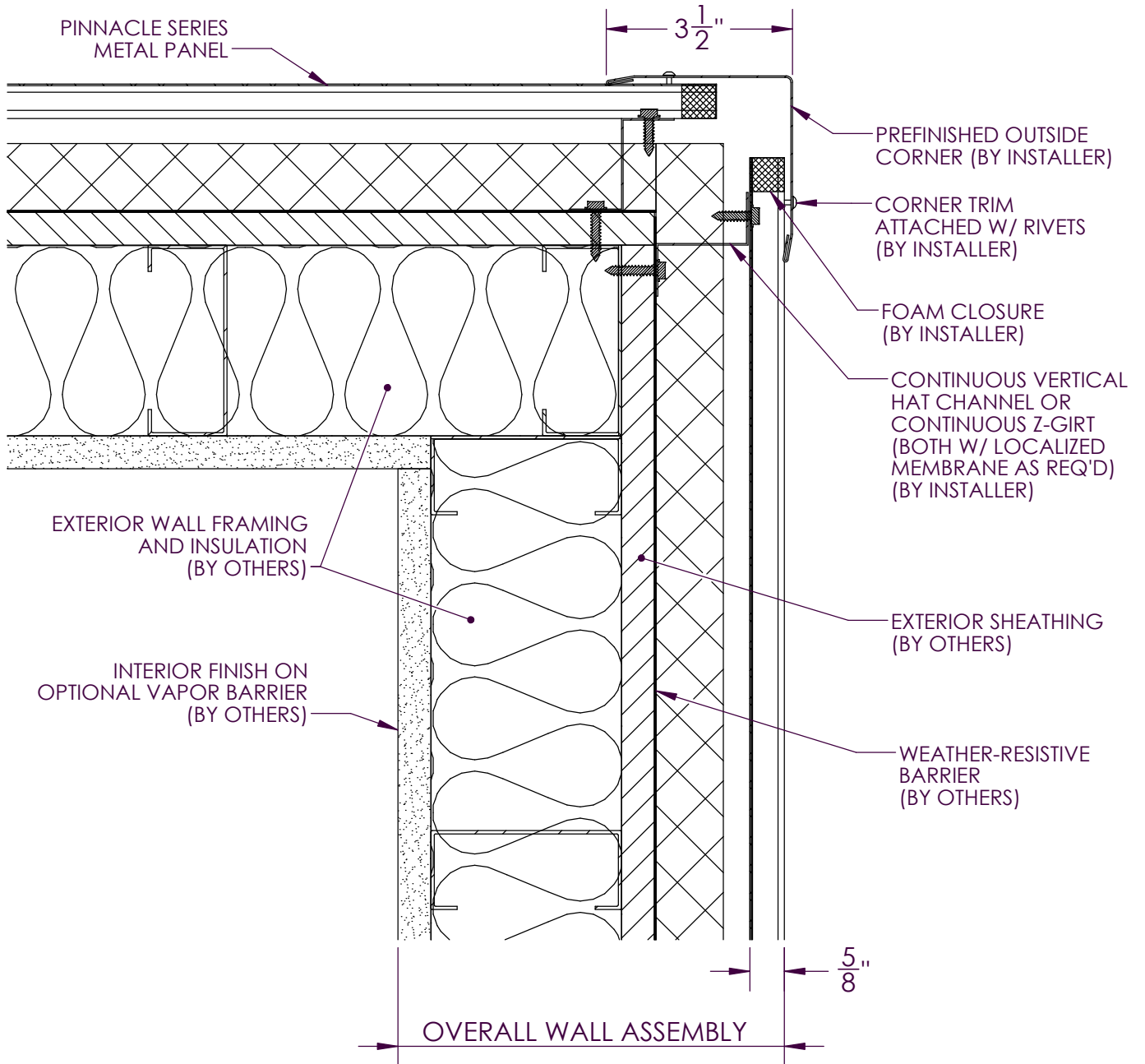



**WAARD
METALS**

PINNACLE SERIES

SOFFIT DETAIL
NO INSULATION

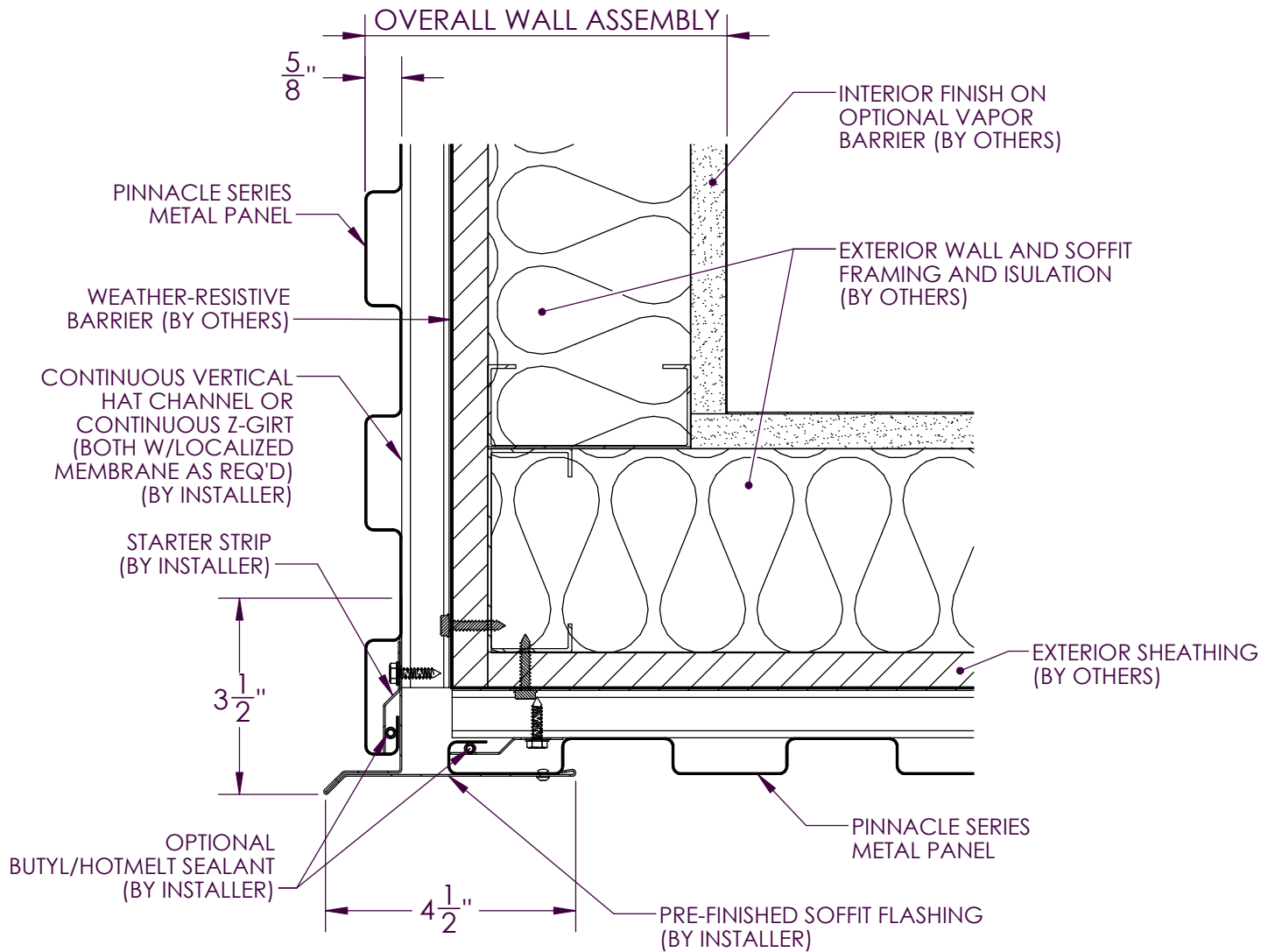



**WAARD
METALS**

PINNACLE SERIES

SOFFIT DETAIL
INSULATION

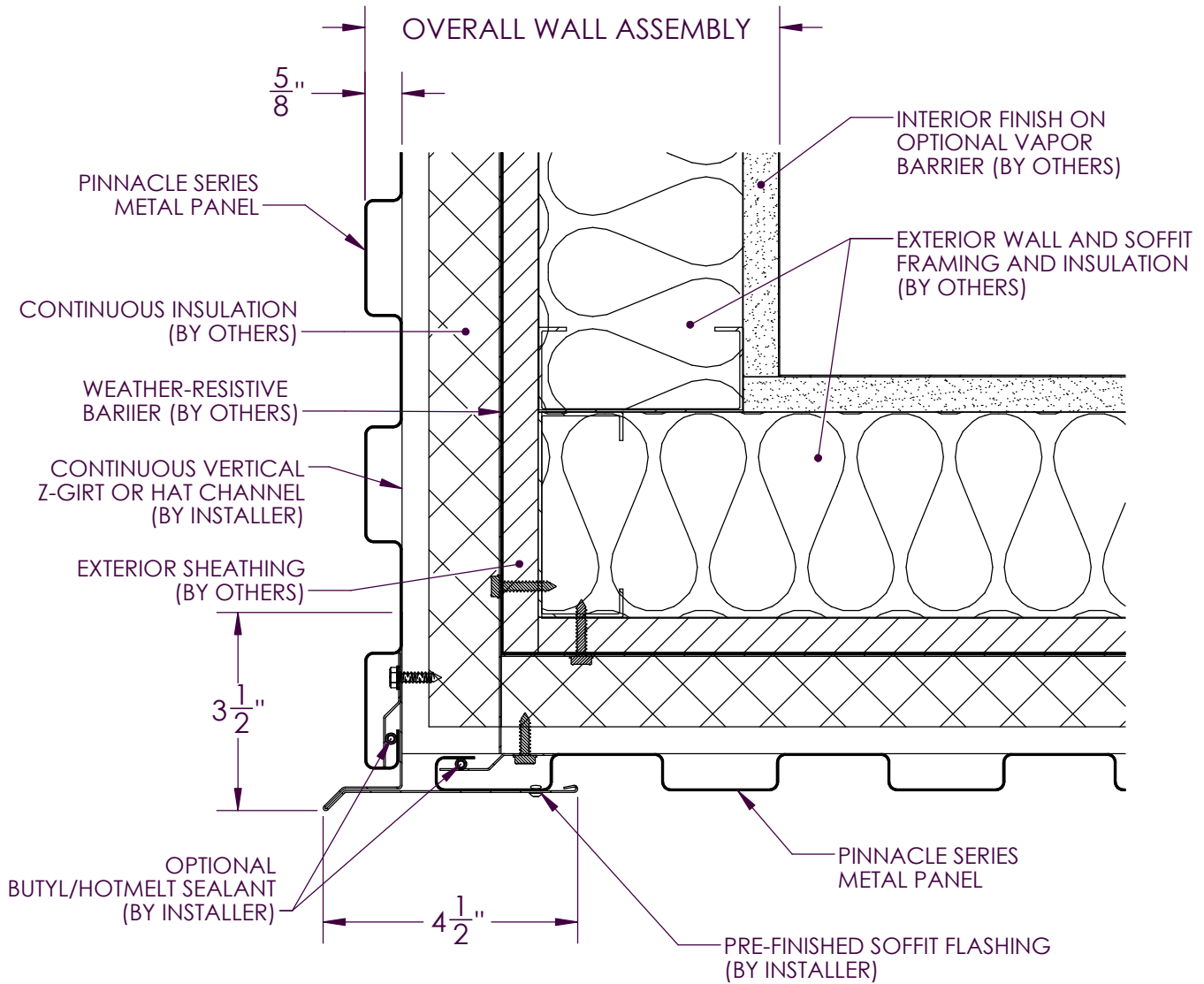



**WAARD
METALS**

PINNACLE SERIES

WINDOW HEAD
NO INSULATION

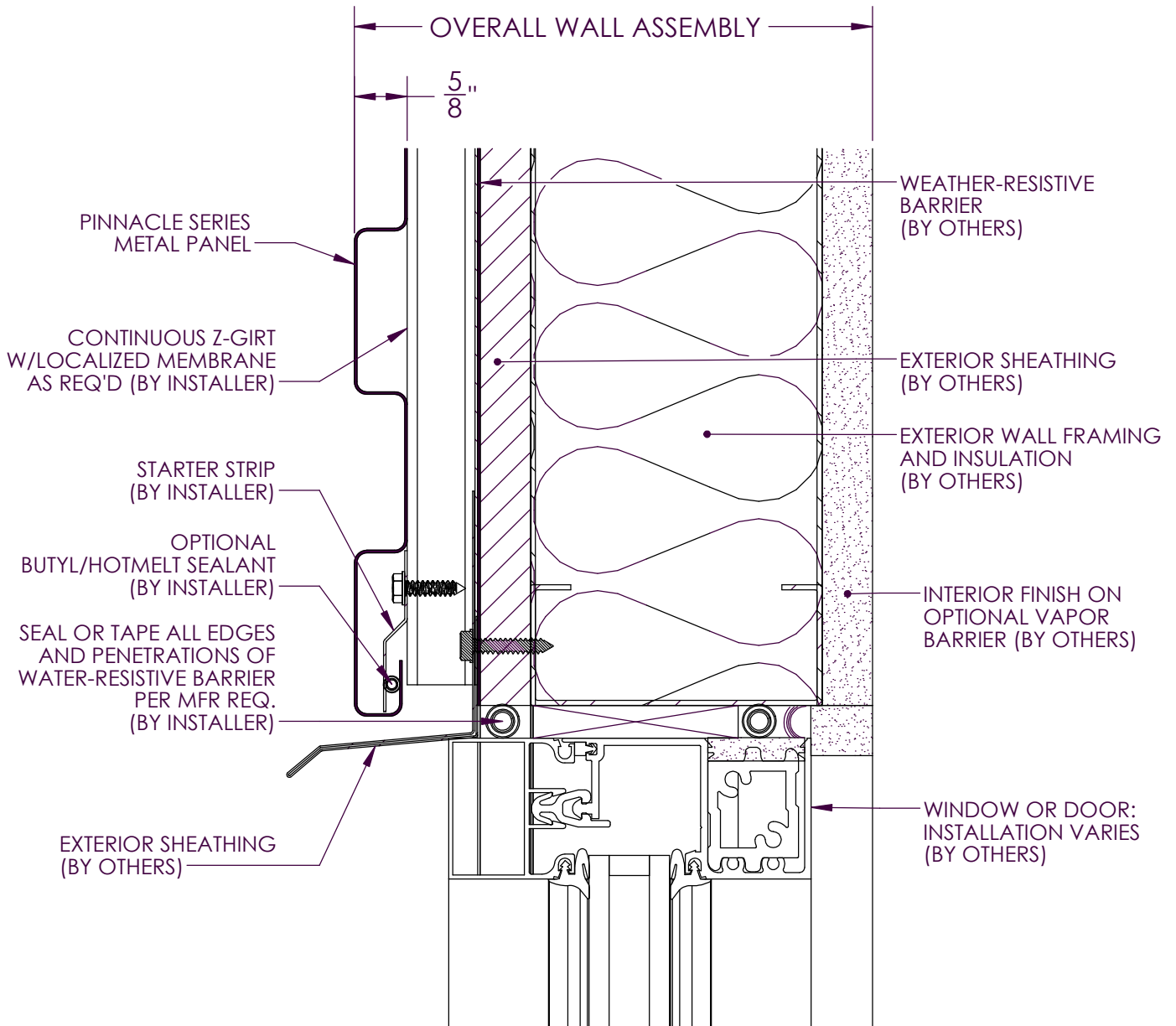



**WAARD
METALS**

PINNACLE SERIES

WINDOW HEAD DETAIL
INSULATION

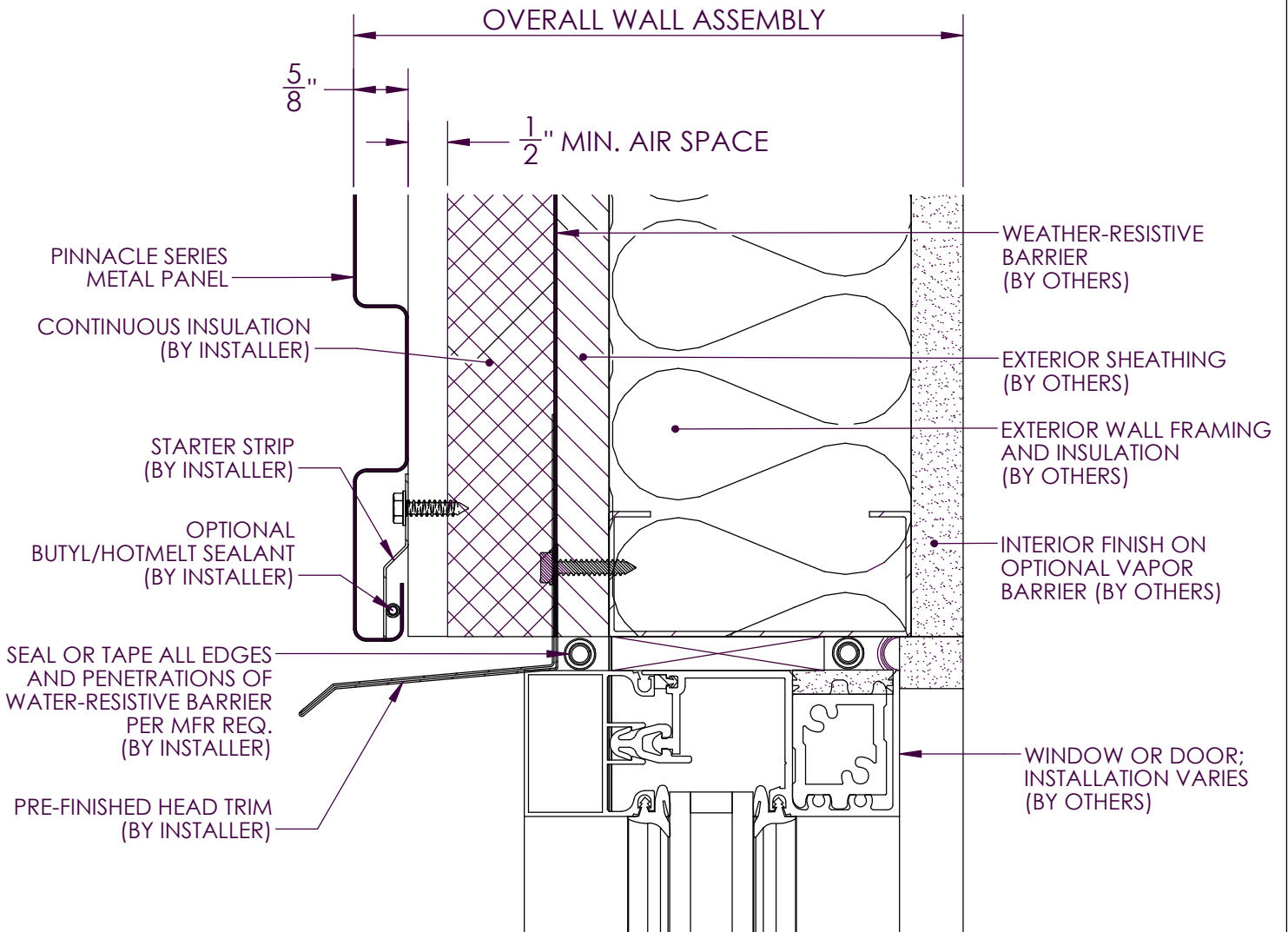



**WAARD
METALS**

PINNACLE SERIES

WINDOW JAMB DETAIL
NO INSULATION

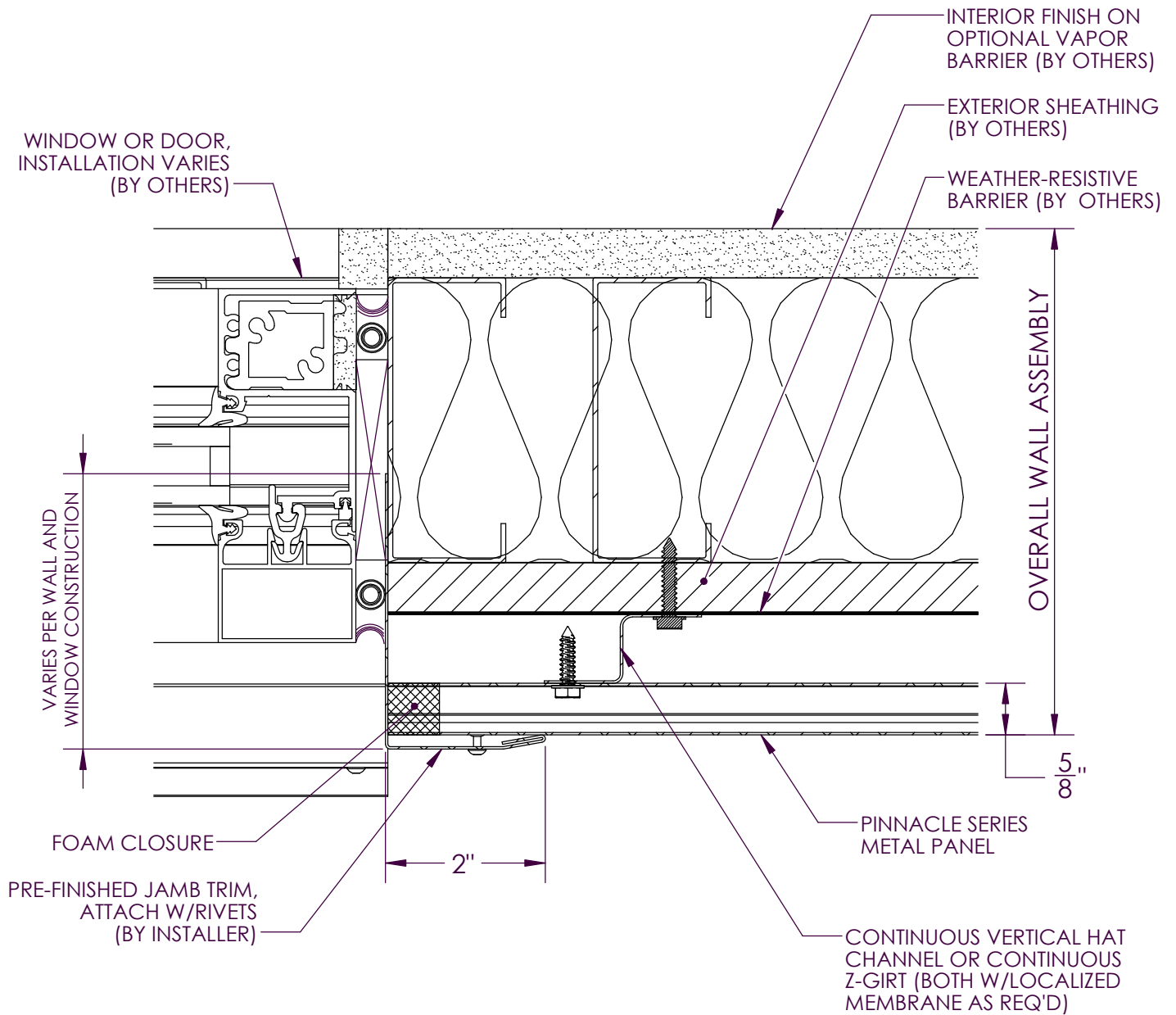



**WAARD
METALS**

PINNACLE SERIES

WINDOW JAMB DETAIL
INSULATION

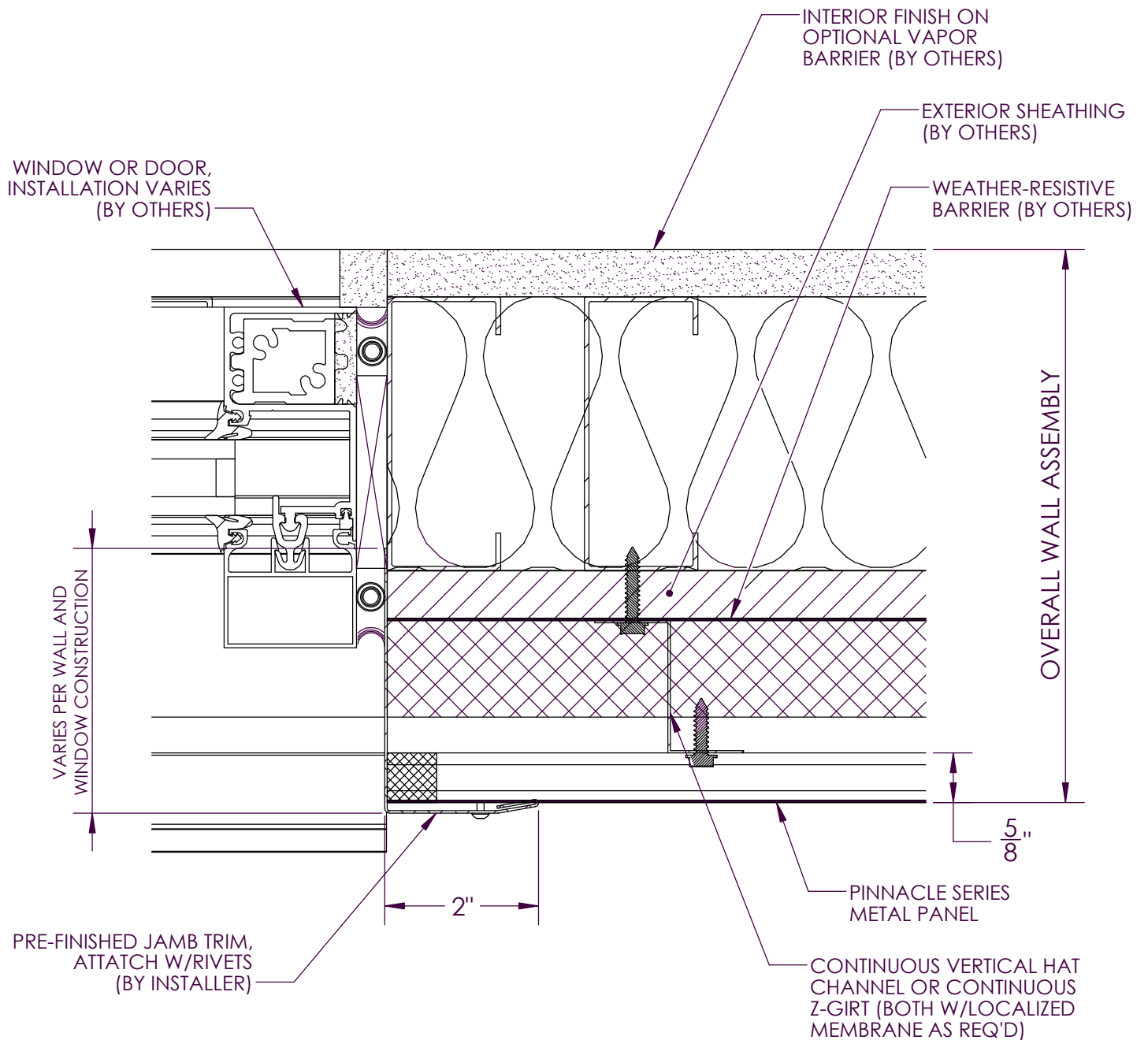



**WAARD
METALS**

PINNACLE SERIES

WINDOW SILL DETAIL
NO INSULATION

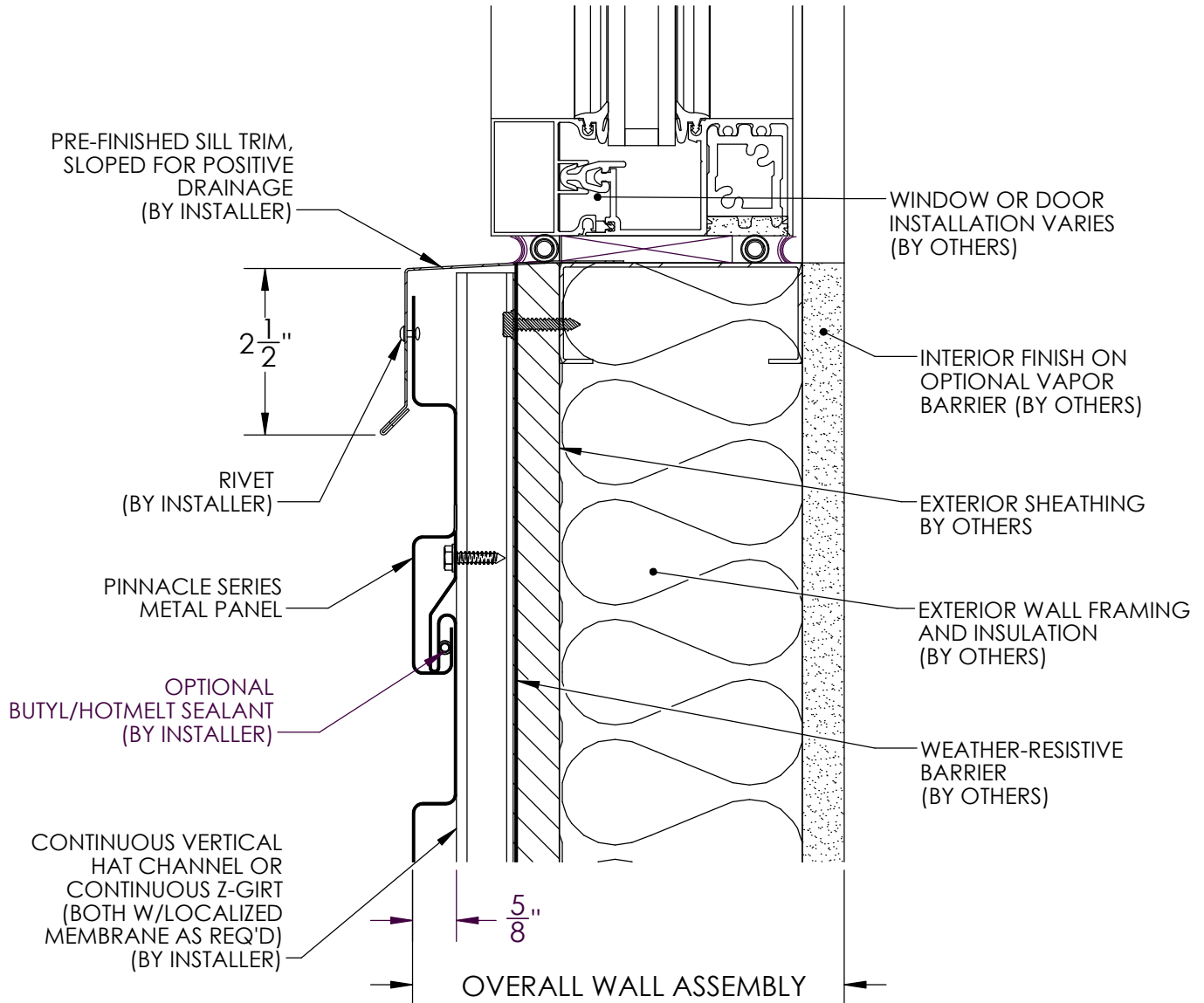



**WAARD
METALS**

PINNACLE SERIES

WINDOW SILL DETAIL
INSULATION

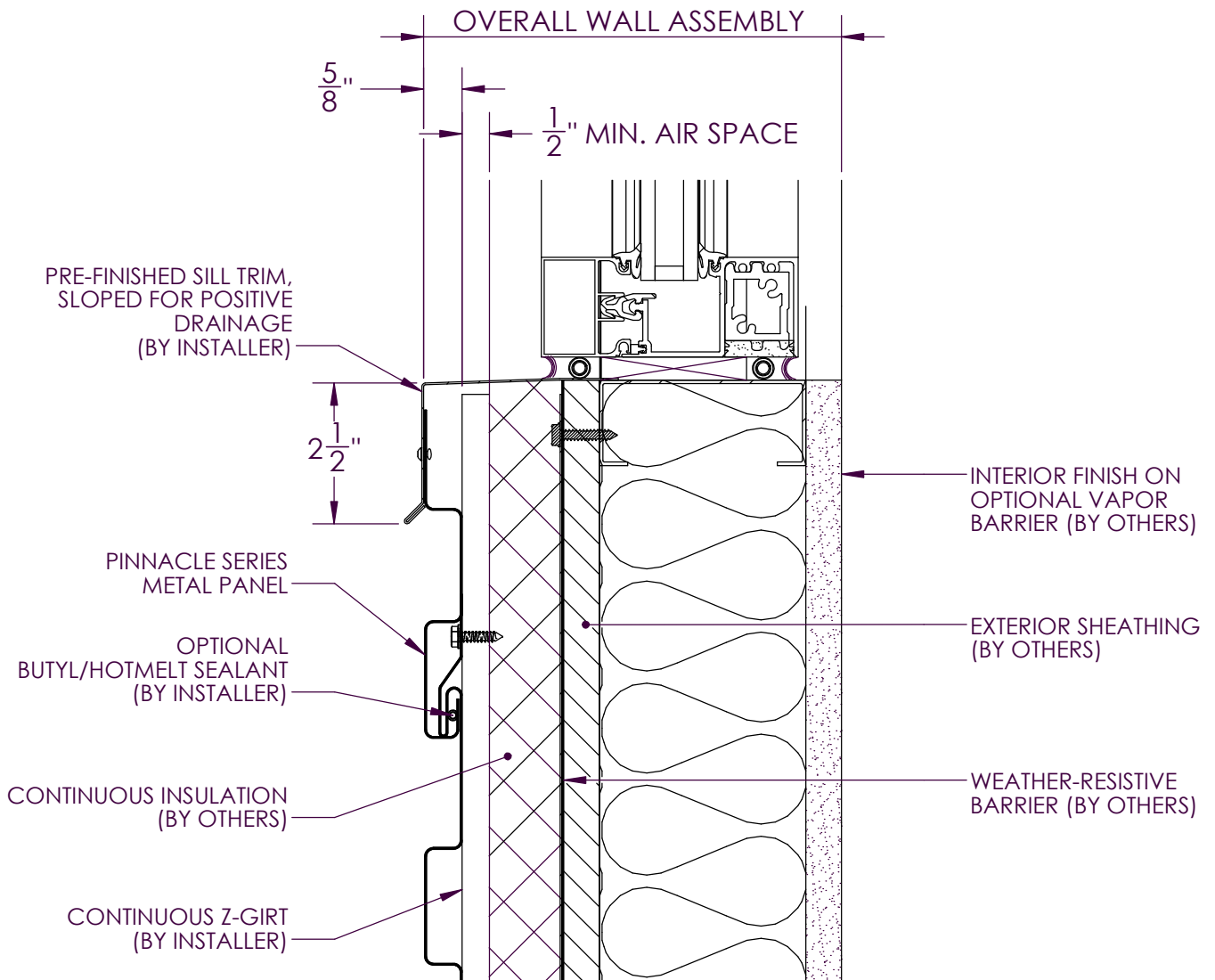



**WAARD
METALS**

PINNACLE SERIES

PANEL JOINT - LAP

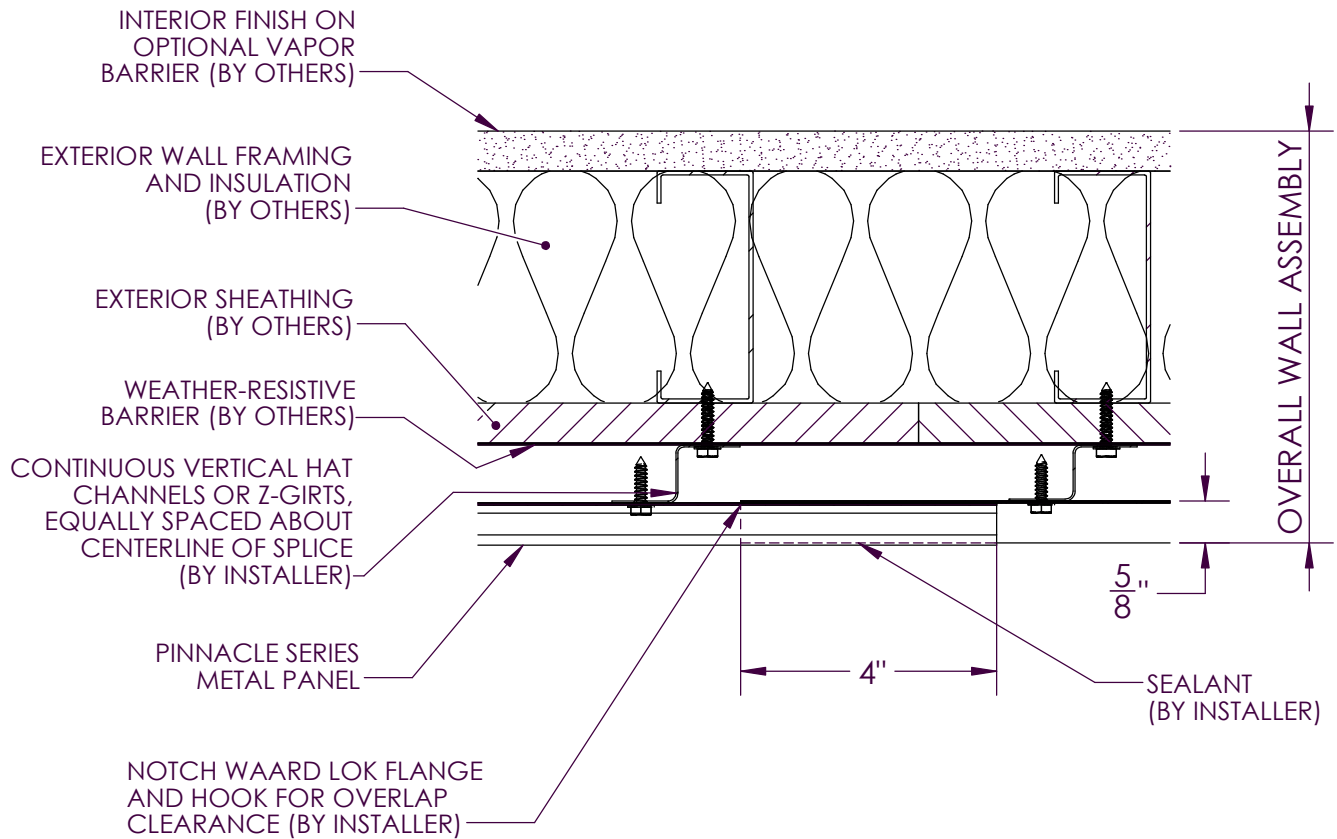



**WAARD
METALS**

PINNACLE SERIES

PANEL JOINT - SPLICE PLATE

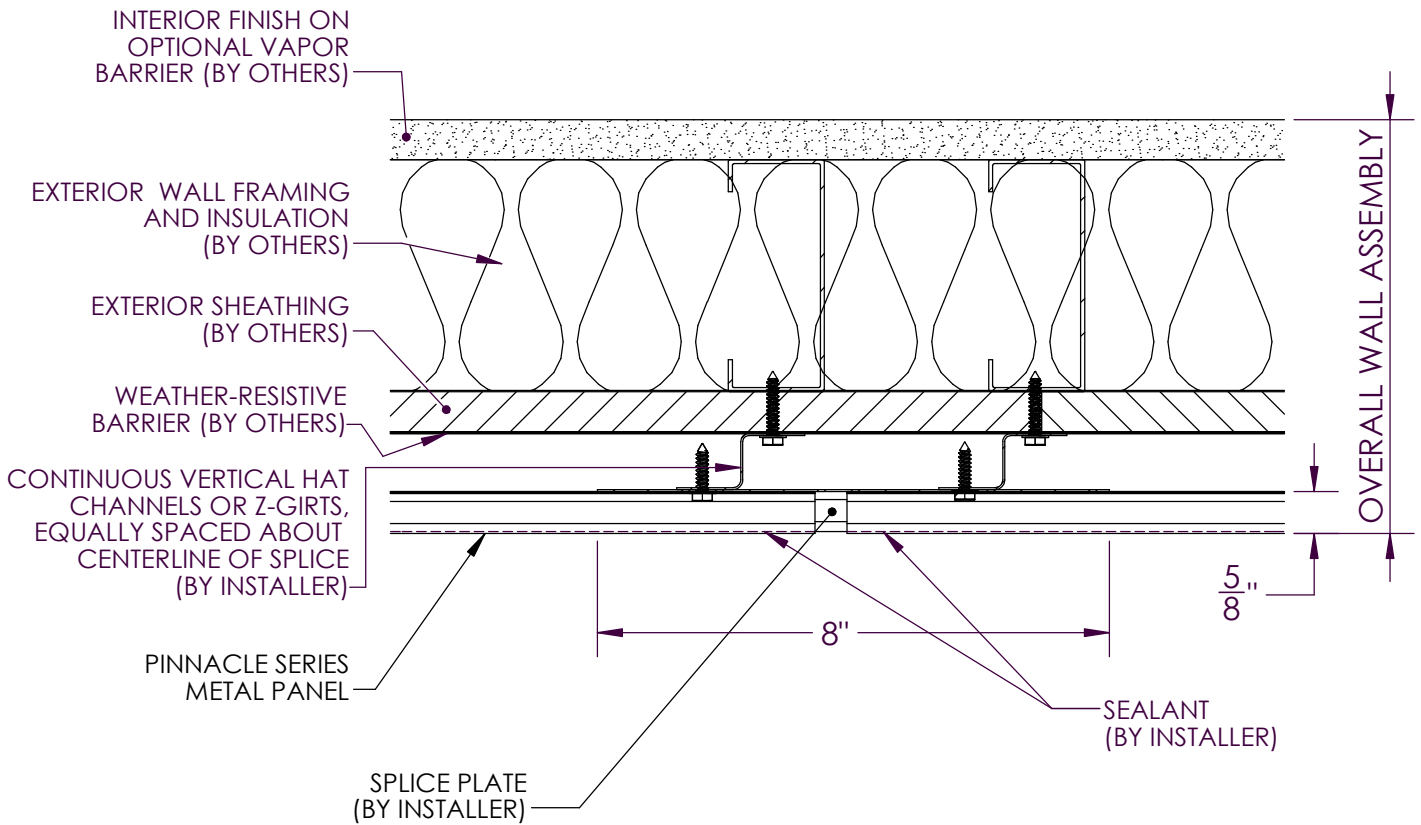



**WAARD
METALS**

PINNACLE SERIES

COVER TRIM DETAIL

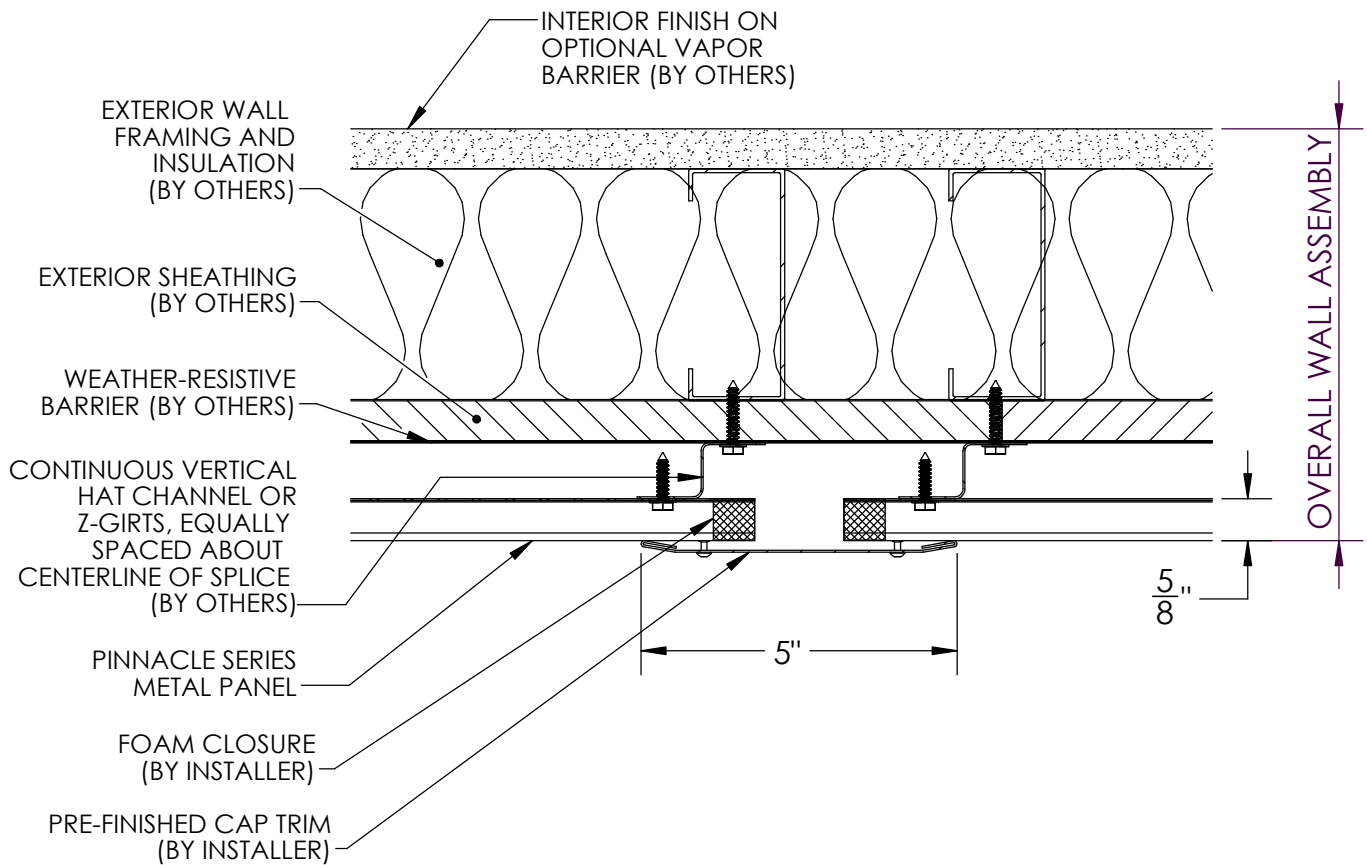



**WAARD
METALS**

PINNACLE SERIES

PANEL JOINT - J-CHANNEL

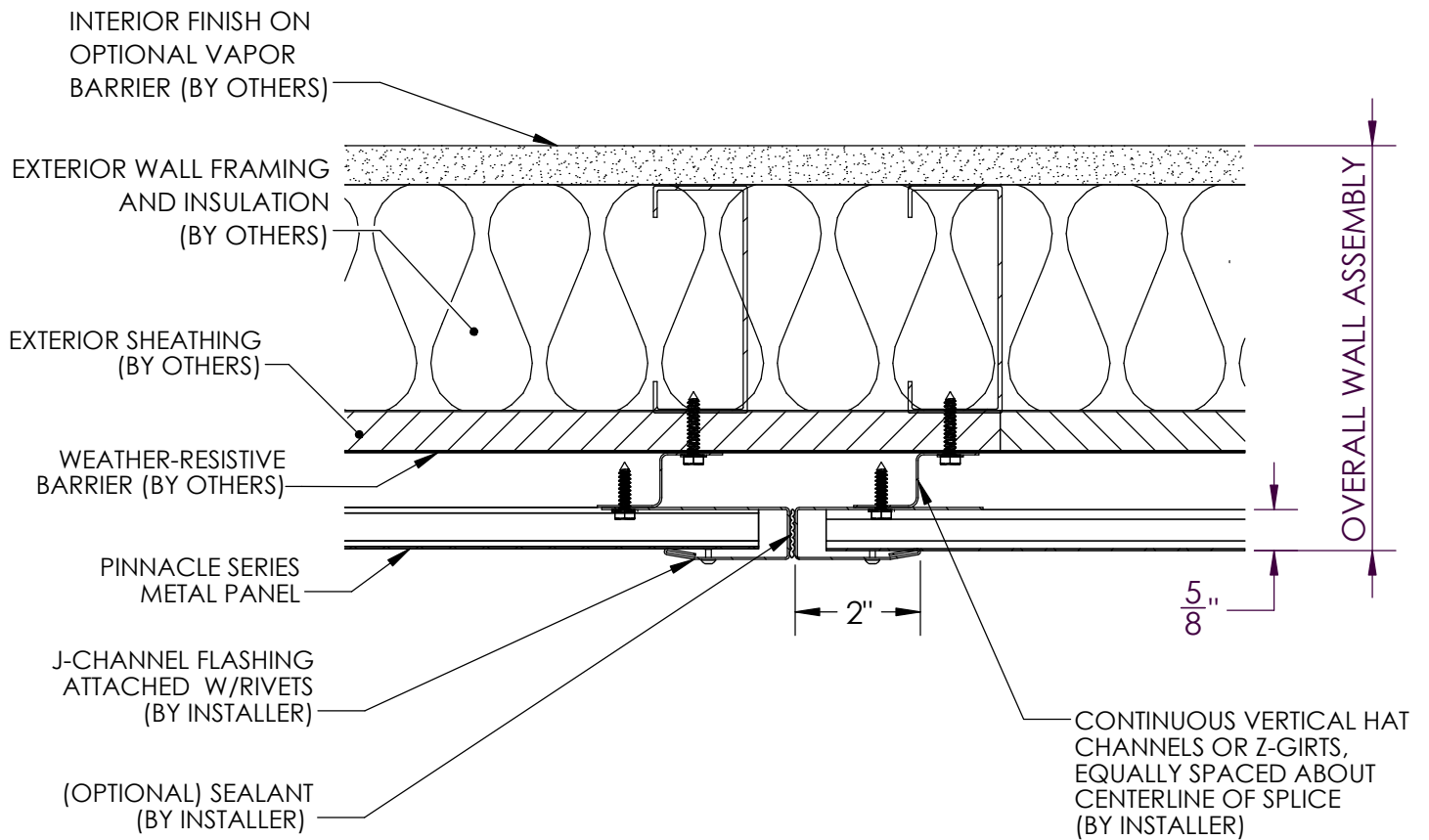



**WAARD
METALS**

PINNACLE SERIES

ISOMETRIC WALL
ASSEMBLY VIEW

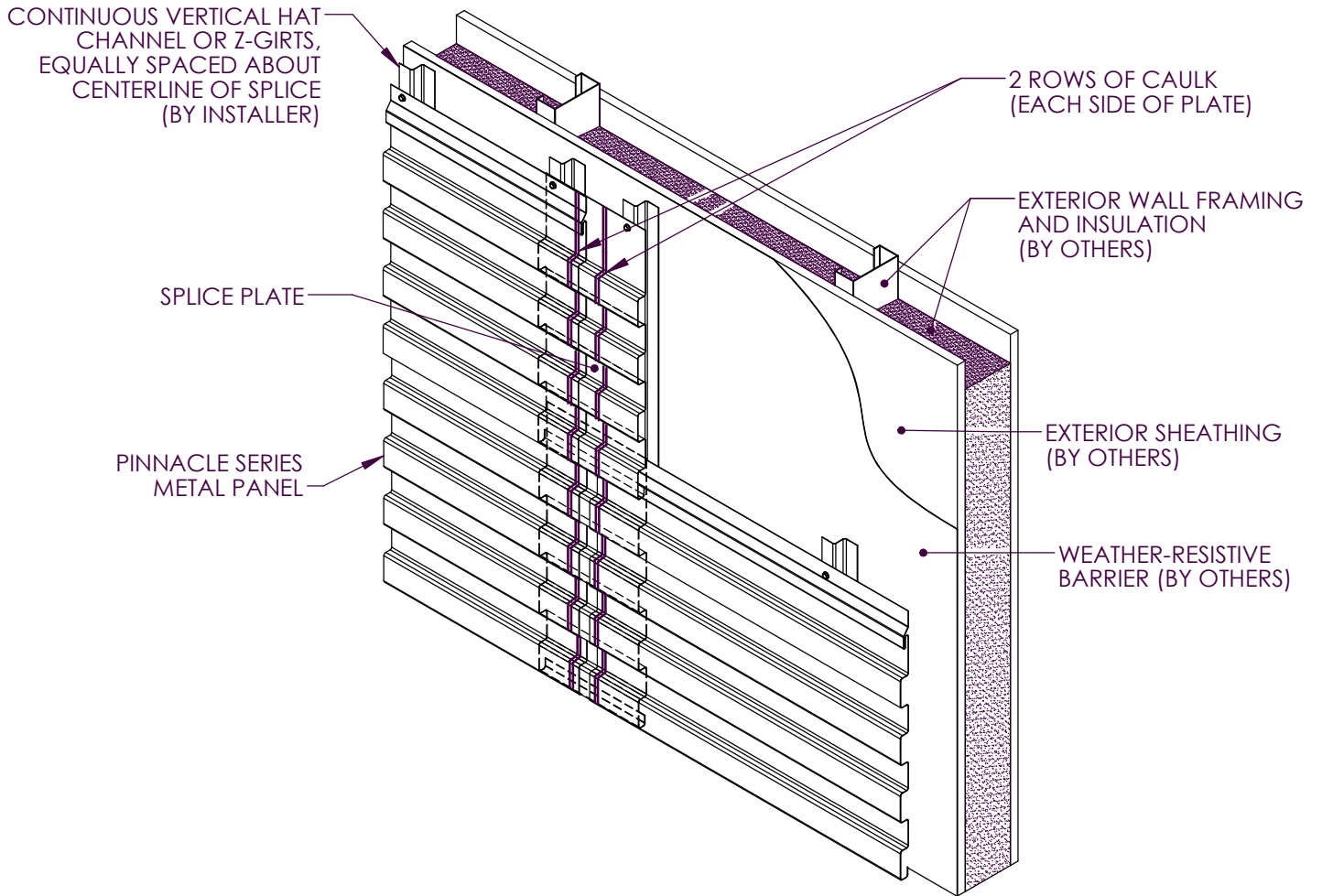



**WAARD
METALS**

PINNACLE SERIES

TRIM PROFILE DETAIL

Z-GIRT AND HAT CHANNEL
PROFILE DIMENSIONS:

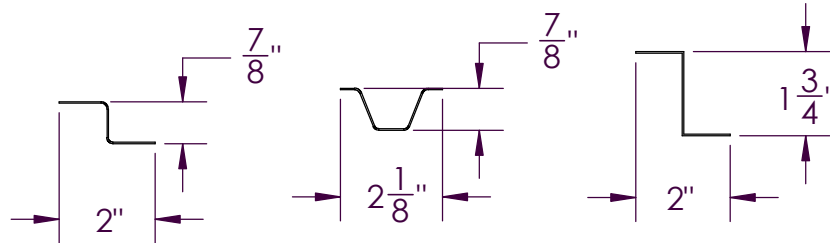

WINDOW JAMB
TRIM

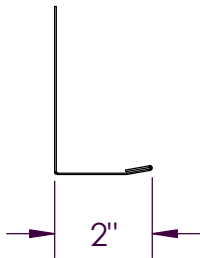

SILL TRIM

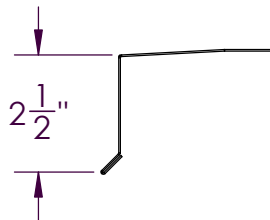

SOFFIT TRIM

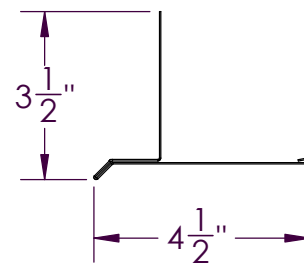

OUTSIDE CORNER

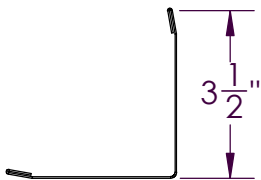

INSIDE CORNER

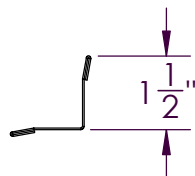

J-CHANNEL

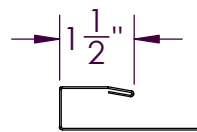

CAP TRIM

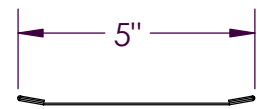

BASE TRIM /
WINDOW HEAD TRIM

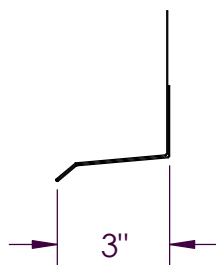

STARTER STRIP

